

 **TEREX**® | **TRUCKS**

A DIVISION OF VOLVO CONSTRUCTION EQUIPMENT

PRODUCT RANGE

RIGID DUMP TRUCKS



COMMITTED TO THE LONG HAUL

RIGID DUMP TRUCKS

RIGID BY NAME, FLEXIBLE BY NATURE KEEPS YOU MOVING MORE FOR LESS

Our range of rigid dump trucks press the perfect balance of power, torque and effective gearing coupled with optimum weight distribution to move more material in less time. With our TR45, TR60, TR70 and TR100, we've got the truck for your needs.

BUILT TO HAUL. BUILT TO LAST.



OUR PRODUCTS

TR45



MAX PAYLOAD MT (US TONS)
41 (45)

HEAPED CAPACITY M³ (YD³)
26 (34)

ENGINE POWER KW (HP)
392 (525)

TR60



MAX PAYLOAD MT (US TONS)
54.5 (60)

HEAPED CAPACITY M³ (YD³)
35 (46)

ENGINE POWER KW (HP)
522 (700)

TR70



MAX PAYLOAD MT (US TONS)
65 (72)

HEAPED CAPACITY M³ (YD³)
41.5 (54.3)

ENGINE POWER KW (HP)
567 (760)

TR100

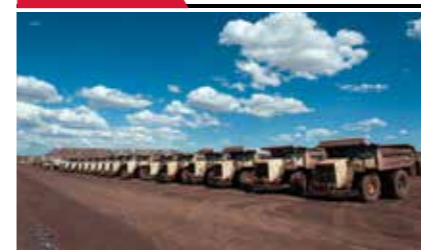

MAX PAYLOAD MT (US TONS)
91 (100)

HEAPED CAPACITY M³ (YD³)
55.5 (72.6)

ENGINE POWER KW (HP)
783 (1050)

CONTENTS

History	04
Rigid Dump Trucks	06
Performance	08
Walkaround	10
Specifications	12
Gradeability & Retardation	20
Equipment	25

Standard configuration data shown may vary according to options and/or country standards.

COMMITTED TO THE LONG HAUL

04

ALWAYS AT THE FOREFRONT OF HAULING APPLICATION SOLUTIONS

Terex Trucks' heritage can be traced back to 1934 when the world's first off-road dump truck was created. This pioneering machine offered a straightforward, no-nonsense solution for every hauling application, from mining to construction work.

Our Motherwell, Scotland facility has been operating since 1950 and is solely dedicated to the production of Terex Trucks. We remain dedicated to pioneering machines that will withstand the test of time by building on the same robust foundations. Not surprisingly, our articulated and rigid dump trucks are trusted by industry professionals the world over, to deliver powerful performances in the most extreme hauling conditions, ranging from intense desert heat to the bitter cold of the Arctic.

We are proud of our strong heritage, technical expertise and effective design, all of which are qualities evident in our rigid trucks. These are all powerful assets for operators within the quarry and mining industries, offering a productive work shift with minimum downtime and maximum return on investment. That, coupled with our competitive aftermarket customer support, ensures your machines move more for longer, and do more for less.



05

TIMELINE



1934
The model 1Z truck- considered to be the first true off-highway rear dump truck.



1950
Euclid Great Britain was formed at Motherwell, Scotland, as a subsidiary and began the development and manufacture of off-highway trucks.



1968
General Motors divested the Euclid brand and the remaining earth moving division is renamed Terex - from the Latin "Terra" (Earth) & "Rex" (King) and 33 Series trucks were introduced.



1998
Both rigid and articulated ranges launched with the introduction of the new white Terex.



2014
The Volvo Group acquire the off-highway truck product line from Terex Corporation and Terex Trucks, a division of Volvo Construction Equipment, is formed.

TODAY

All Terex Trucks are manufactured in Scotland where we are proud of our heritage, technical expertise and modern processes. With ongoing technological improvements, we continue to provide customers in the heavy construction, quarry and mining industries with the high quality, reliable and productive equipment they require.

MOVE MORE, BURN LESS

06 DESIGNED TO PROVIDE YOU WITH THE MOST EFFICIENT AND PRODUCTIVE MACHINE, OUR TEREX TRUCKS RIGID HAULERS ACTIVELY WORK TO LOWER YOUR OPERATING COSTS. BY OUTPERFORMING THE COMPETITION, WE GET YOU STEEPER AND DEEPER.

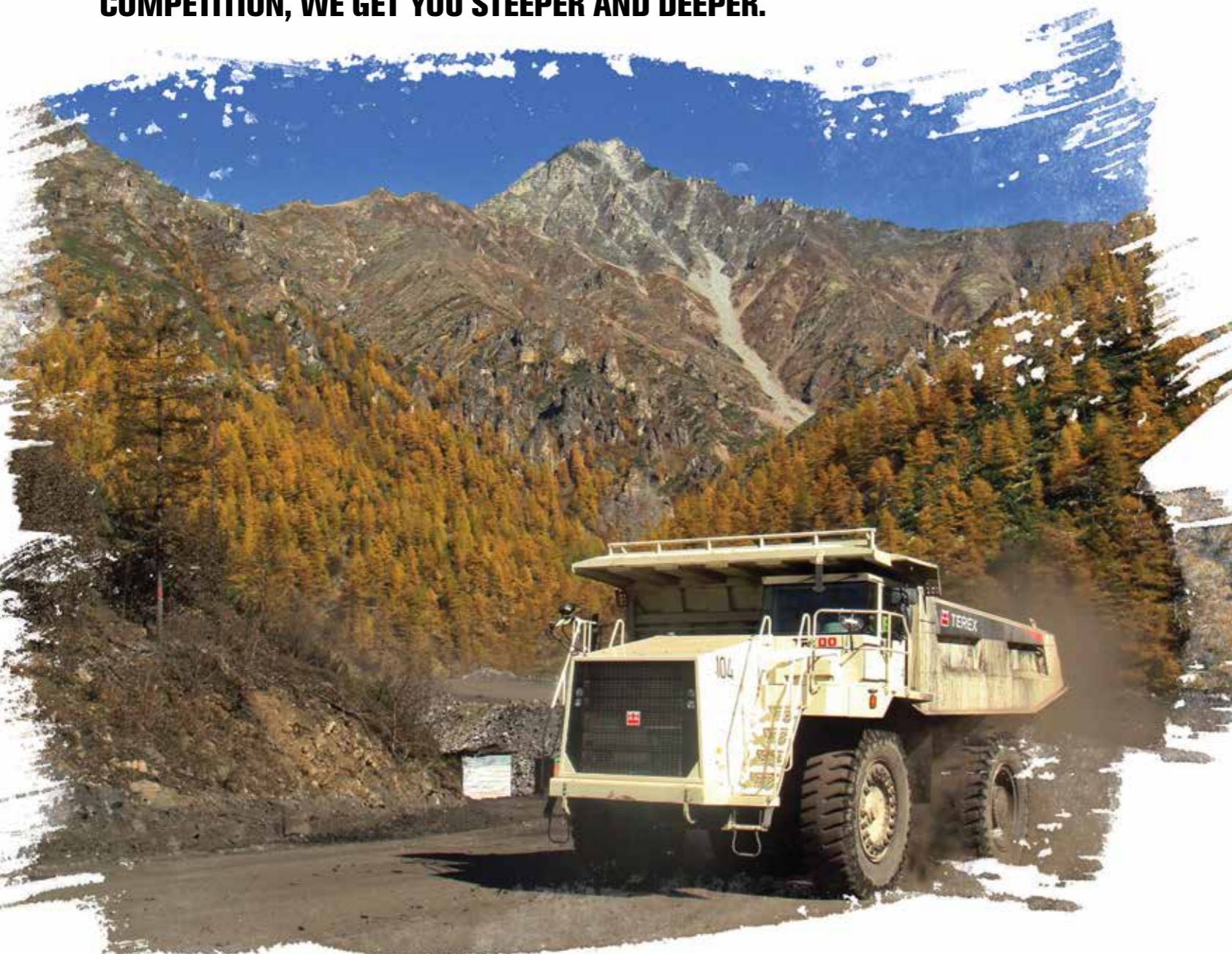

Dual retardation with brake and transmission retarders:

Providing the operator with an option of transmission retardation versus traditional braking on varying conditions results in excellent driving control, shorter cycle times, and lower operating costs. By utilising the transmission retarder you extend the life of your machines' primary braking system. As the only rigid truck in the market that offers transmission retardation as standard on each of our models, it's just another way we help you reduce your operational costs and increase machine availability.

Uncomplicated, proven design:

Our straightforward and sturdy design is proven in countless working environments. The frame assembly incorporates a reserve of structural strength well beyond what is required to absorb the stresses imposed when travelling on uneven, high rolling resistance applications. Our machines promote long life, minimal maintenance – for optimal productivity and lower operational costs.

Tyres:

The Terex Trucks rigid dump trucks promote excellent weight and distribution, resulting in a competitive and productive operation through extended tyre life, reduced fuel costs and reduced haul road impact.**

** Based on recommended machine maintenance and operation procedures being upheld.



INCREASING YOUR PRODUCTIVITY ONE LOAD AT A TIME

08

Drivetrain

The entire drivetrain provides excellent pulling performance and class leading rimpull, resulting in excellent productivity on steep inclines and poor ground conditions. Our machines have the balance between weight, power & gearing that transfers effective productive drive to the wheels on all applications.

Engine

Our strong, reliable, heavy-duty engines are calibrated specifically for all hauler applications providing excellent reliability and is the basis for productive torque and rimpull. The electronically connected drivetrain in our engines* and in-cylinder design optimises fuel combustion, ensuring best power delivery and competitive fuel economy.

Hydraulics

Light operator controls reduce operator fatigue while the steering accumulator provides uniform steering regardless of engine speed. The primary hydraulic systems (steering and brakes) are supply on demand via variable displacement pumps feeding nitrogen over oil accumulators. Independent circuits for front and rear brake systems incorporating nitrogen/hydraulic accumulators for instant braking response and emergency applications ensure high levels of safety and machine protection.



09

Terex Trucks Factory Approved Parts

Terex Trucks Aftermarket support offers Factory Approved Parts that prevent unscheduled downtime, lowering your operational costs. The compliant, safety-tested and verified components maximise truck performance, efficiency and longevity.

Our parts evolve with the latest technology and materials with warranty guaranteed; ensuring your trucks work when you need them.



Service and Maintenance

Our rigid truck's uncomplicated, straightforward design offers many benefits that keep your downtime and operational costs to a minimum and productivity to the maximum. Easy-access service points allow for safe, ground level maintenance and the on-board diagnostic interfaces promotes fast service intervention time.

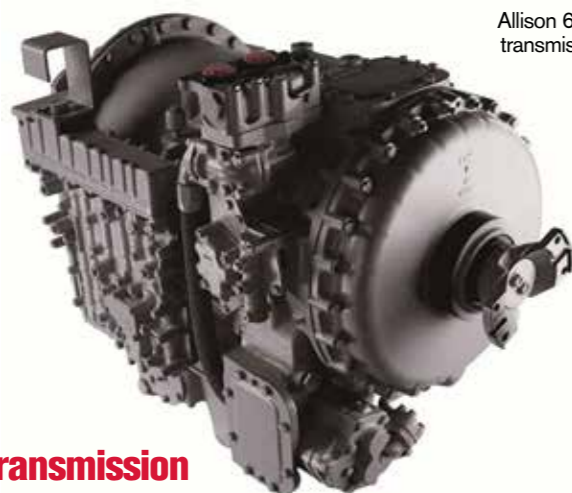

Allison 6620 transmission



Cummins QSK19 Engine

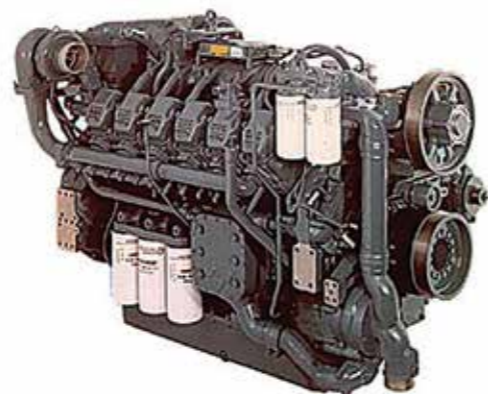

MTU12V20009 Engine

Transmission

Terex Trucks rigid's planetary gearing and integral retarder provide smooth unsurpassed gearshifts for excellent momentum and acceleration on all hauler applications. Designed for high productivity and low operator fatigue, it easily adapts to provide tailored performance suitable to all hauler applications.

*In models except the TR100 Cummins KTA38.

DRIVING RESULTS

10

11

Operator
Spacious and ergonomic layout for comfort, productivity and safe operation. On-board diagnostics result in quicker maintenance resolutions.

Engine
With efficient fuel consumption and low cost of operation, our high performance engine packages provide excellent productivity.

Chassis
Durability and longer life, even on the toughest of working applications due to our proven, robust and reliable design.

Design
Easy maintenance and operation delivered by uncomplicated design and robust construction that is well proven, to maximise return on your investment.

Body
Clean dumping and increased productivity comes with our standard exhaust heating. The abrasive/high impact resistant high-capacity body boasts excellent material retention.

Balance
A perfect balance between efficient power, effective gearing and weight distribution allows your Terex Truck to move more materials faster and more efficiently.

Tyres
Excellent weight distribution promotes long tyre life via reduced load impact and stresses, further reducing your operational costs.

Rear Axle
Excellent traction performance on all working conditions from the highly effective drivetrain gear reduction.

Transmission
Your service brake life is extended with the smooth shifting Allison Planetary Transmissions with standard Integral Hydraulic Retarder for excellent performance and control. Two shift schedules provide efficient drivetrain gearing for productive performance on all conditions.

Rear Brakes
Safe performance and long life are benefits delivered by the force cooled multi-disc brakes, internal fail safe emergency/park brake piston and rear brake retarder.



TR45

TR60

ENGINES

Engine	Cummins QSK19-C525	Cummins QSK19-C700
Type	Four cycle, emission certified, high pressure common rail (TR45 & TR60), direct injection diesel, water cooled, turbo charged and charge air cooled	
Cylinder/Configuration litres (in ³)	6 in line	6 in line
Piston Displacement - litres (in ³)	19 (1,150)	19 (1,150)
Bore x Stroke - mm (in)	159 x 159 (6.25 x 6.25)	159 x 159 (6.25 x 6.25)
Gross Power - kW (hp) @ rpm	392 (525) @ 2000	522 (700) @ 2000
Net Power - kW (hp) @ rpm	370 (495) @ 2000	481 (645) @ 2000
Maximum Torque - Nm (lbf ft) @ rpm	2407 (1775 @ 1500)	2981 (2199) @ 1500
Gross Power rated	SAE J1995	SAE J1995
Engine emissions	Meets USA EPA Tier 3/CARB MOH 40 CFR 89 non-road mobile machinery directive, stage 3	Meets USA EPA Tier 3/CARB MOH 40 CFR 89 non-road mobile machinery directive, stage 3
Electrical	24 volt negative ground electrical system. Two 12 volt 180 Ah batteries. 9kW (12hp) electric starter. Neutral start. 70A alternator with integral voltage regulator	
Altitude - Electronic derate @ m (ft)	2 743 (9000)	1 524 (5000)

TRANSMISSION

		Allison H5620AR automatic		Allison H6620AR automatic	
Assembly		Mid-mounted in the frame for ease of access with integral torque converter, hydraulic retarder and planetary gearing. Automatic electronic control with softshift feature. Automatic lock-up in all speed ranges.			
Electronic Control		CEC2		CEC2	
Speeds - km/h (mph)	Gear	Forward	Reverse	Forward	Reverse
	1	11.3 (7.0)	7.1 (4.4)	9.9 (6.1)	6.6 (4.1)
	2	16.8 (10.5)	12.9 (8.0)	14.6 (9.1)	11.8 (7.3)
	3	22.4 (13.9)		19.5 (12.1)	
	4	33.4 (20.8)		29.1 (18.1)	
	5	45.2 (28.1)		39.3 (24.4)	
	6	65.0 (40.4)		57.5 (35.7)	

TYRES AND WHEELS

Types	21.00-35	24.00-35
Rims	15	17

Consult tyre manufacturers for optimum tyre selection and current + - km/h (ton-mile/h) capacity for application

AXLES

Heavy duty axle with full floating axle shafts, single reduction spiral bevel gear differential, and planetary reduction at each wheel		
	Standard	Standard
Differential ratio	3.15:1	3.73:1
Planetary reduction	5.66:1	5.80:1
Overall Drivetrain reduction	17.83:1	21.63:1

TR60

TR100

TR100D

Detroit Diesel/MTU-2000TA	Cummins KTA38-C	Detroit Diesel/MTU-2000TA
Four cycle, emission certified, direct injection diesel, water cooled, turbo charged and charge air cooled		
V12	V12	V16
24.0 (1,464)	37.8 (2,300)	31.9 (1,945)
130 x 150 (5.11 x 5.91)	159 x 159 (6.25 x 6.25)	130 x 150 (5.11 x 5.91)
567 (760) @ 2100	783 (1050) @ 2100	783 (1050) @ 2100
511 (685) @ 2100	770 (1033) @ 2100	703 (943) @ 2100
3323 (2450) @ 1350	4631 (3515) @ 1300	4461 (3290) @ 1350
SAE J1995	SAE J1995	SAE J1995
Meets USA EPA Tier 2/CARB MOH 40 CFR 89 and EU MOH roads mobile machinery directive, stage 2	Non-certified	Meets USA EPA Tier 2/CARB MOH 40 CFR 89 and EU MOH roads mobile machinery directive, stage 2
24 volt negative ground electrical system. Two 12 volt 200 Ah batteries. 7.7kW (10hp) electric starter. Neutral start. 100A alternator.	24 volt negative ground electrical system. Four 12 volt 200 Ah batteries. Two 9kW (12hp) electric starters. Neutral start. 70A alternator with integral voltage regulator.	24 volt negative ground electrical system. Four 12 volt 200 Ah batteries. 9kW (12hp) electric starter. Neutral start. 100A alternator.
3 100 (10,170)	N/A	3 100 (10,170)

		Allison H6620AR automatic		Allison H8610AR automatic		Allison H8610AR automatic	
Assembly		Mid-mounted in the frame for ease of access with integral torque converter, hydraulic retarder and planetary gearing. Automatic electronic control with softshift feature. Automatic lock-up in all speed ranges.					
Electronic Control		CEC2		CEC2		CEC2	
Speeds - km/h (mph)	Gear	Forward	Reverse	Forward	Reverse	Forward	Reverse
	1	9.5 (5.9)	7.4 (4.6)	8.2 (5.1)	6.0 (3.8)	8.2 (5.1)	6.0 (3.8)
	2	14.2 (8.8)	11.0 (6.8)	15.0 (9.3)		15.0 (9.3)	
	3	18.9 (11.8)		20.6 (12.8)		20.6 (12.8)	
	4	28.2 (17.5)		26.5 (16.5)		26.7 (16.6)	
	5	38.1 (23.7)		34.8 (21.6)		34.8 (21.6)	
	6	57.0 (35.5)		47.6 (29.6)		48.5 (30.1)	

24.00 R35	27.00-49	27.00-49
17	19.5	19.5

Consult tyre manufacturers for optimum tyre selection and current + - km/h (ton-mile/h) capacity for application

Heavy duty axle with full floating axle shafts, single reduction spiral bevel gear differential, and planetary reduction at each wheel					
	Standard	Standard	Optional	Standard	Optional
Differential ratio	3.73:1	2.16:1	2.16:1	2.16:1	2.16:1
Planetary reduction	5.80:1	13.75:1	10.50:1	13.75:1	10.50:1
Overall Drivetrain reduction	21.63:1	29.70:1	22.68:1	29.70:1	22.68:1

TR45

TR60

SUSPENSION

Front	Terex manufactured king pin strut-type independent front wheel suspension with self contained, variable rate, nitrogen/oil cylinders	
Rear	Terex variable rate nitrogen/oil cylinders with A-frame linkage and lateral stabilizer bar	
Maximum front strut stroke - mm (in)	251 (9.9)	251 (9.9)
Maximum rear strut stroke - mm (in)	192 (7.6)	192 (7.6)
Maximum rear axle oscillation - deg	± 6.5	± 6.5

BRAKES

	<p>All hydraulic brake system control. Transmission mounted pressure compensating piston pump provides hydraulic pressure for brakes and steering. Independent circuits front and rear.</p> <p>Each circuit incorporates a nitrogen/hydraulic accumulator which stores energy to provide rapid braking response and emergency supply</p>	
Front brakes type	Dry disc	Dry disc
Front brake diameter - mm (in)	660 (26)	710 (28)
Front brakes lining area - cm ² (in ²)	1395 (216)	1395 (216)
Rear brakes type	Terex force oil cooled, multiple disc	
Rear brake diameter - mm (in)	-	-
Rear brakes lining area - cm ² (in ²)	38,310 (5938)	47,151 (7308)
Parking	Rear brakes applied by spring loaded opposing piston on disc pack, hydraulically released	
Secondary	Park push button solenoid control applies service and parking brakes. Automatically applies when engine is switched off. Brakes conform to ISO 3450	
Retardation	Lever control of rear disc brakes or hydraulic retarder in transmission	

STEERING

	<p>Independent hydrostatic steering with closed-centre steering valve, accumulator and pressure compensating piston pump. Accumulator provides uniform steering regardless of engine speed. In the event of loss of engine power the accumulator provides steering of approximately two lock-to-lock turns. A low pressure indicator light warns of system pressure below 82 bar(1,190psi). Steering conforms to ISO 5010.</p>	
Maximum tyre steering angle - degrees	39	39
SAE Turning Radius - mm (ft-in)	9475 (31-1)	9540 (31-4)
Clearing Radius mm (ft-in)	10,500 (34-5)	10,600 (34-9)

FRAME

	<p>Full box section frame rails, integral front bumper, closed-loop crossmember and torque tubes of 290 MPa yield strength steel. Crossmember connections are 655 Mpa (95 000 lbf/in²) steel castings.</p>	
--	---	--

TR60

TR100

TR100D

	<p>Terex manufactured king pin strut-type independent front wheel suspension with self contained, variable rate, nitrogen/oil cylinders</p> <p>Terex variable rate nitrogen/oil cylinders with A-frame linkage and lateral stabilizer bar</p>		
	235 (9.25)	235 (9.25)	235 (9.25)
	193 (7.6)	175 (6.9)	175 (6.9)
	± 7.5	± 7.0	± 7.0

	<p>All hydraulic brake system control. Transmission mounted pressure compensating piston pump provides hydraulic pressure for brakes and steering. Independent circuits front and rear.</p> <p>Each circuit incorporates a nitrogen/hydraulic accumulator which stores energy to provide instant braking response and emergency supply.</p>		
	Dry disc	Dry disc	Dry disc
	710 (28)	965 (38)	965 (38)
	2788 (432)	2015 (320)	2015 (320)
	Terex force oil cooled, multiple disc		
	-	-	-
	67,390 (10,445)	87,567 (13,573)	87,567 (13,573)
	Rear brakes applied by spring loaded opposing piston on disc pack, hydraulically released		
	Park push button solenoid control applies service and parking brakes. Automatically applies when engine is switched off. Brakes conform to ISO 3450		
	Lever control of rear disc brakes or hydraulic retarder in transmission		

	<p>Independent hydrostatic steering with closed-centre steering valve, accumulator and pressure compensating piston pump. Accumulator provides uniform steering regardless of engine speed. In the event of loss of engine power the accumulator provides steering of approximately two lock-to-lock turns. A low pressure indicator light warns of system pressure below 82 bar(1,190psi). Steering conforms to ISO 5010.</p>		
	42	39	39
	9760 (32-0)	12,230 (40-1)	12,230 (40-1)
	11,200 (36-9)	12,650 (41-6)	12,650 (41-6)

	<p>Full box section frame rails, integral front bumper, closed-loop crossmember and torque tubes of 290 MPa yield strength steel. Crossmember connections are 655 Mpa (95 000 lbf/in²) steel castings.</p>		
--	---	--	--

TR45

TR60

BODY

	Longitudinal 'V' type floor with integral transverse box-section stiffeners. The body is exhaust heated and rests on resilient impact absorption pads	
Body floor wear surface	Are high hardness Hardox (360-440BHN) abrasion resistant steel of yield strength 1 000 MPa (145 000 lbf/in ²)	
Plate thickness		
Floor mm (in)	19.0 (0.75)	19.0 (0.75)
Sides mm (in)	10.0 (0.39)	10.0 (0.39)
Front mm (in)	10.0 (0.39)	10.0 (0.39)
Body Volume		
Stuck m ³ (yd ³)	19.6 (25.6)	26.0 (34.0)
Heaped 2:1 (SAE) m ³ (yd ³)	26.0 (34.0)	35.0 (46.0)

HOIST

	Two body hoist cylinders are mounted between the frame rails. Cylinders are two-stage with power down in the second stage. Float to chassis and over-centre kick-over control.	
System relief pressure - bar (PSI)	190 (2750)	16.0 (0.63)
Pump output flow rate - litre/min (US Gal.)	227 (60) @ 2100	227 (60) @ 2100
Body raise time - seconds	13	16.4
Body lower time - seconds	9	16.3

SERVICE DATA

Standard Unit	litres (US Gal.)	litres (US Gal.)
Engine Crankcase and Filters	60.0 (15.9)	60.0 (15.9)
Transmission and Filters	76.0 (20.1)	92.0 (24.3)
Cooling System	126.0 (32.0)	136.0 (36.0)
Fuel Tank	606.0 (160.0)	606.0 (160.0)
Steering Hydraulic Tank	68.0 (18.0)	68.0 (18.0)
Steering Hydraulic System (Total)	92.0 (24.3)	92.0 (24.3)
Body Hydraulic Tank	250.0 (66.0)	250.0 (66.0)
Body Hydraulic & Brake Cooling System (Total)	385.0 (101.7)	385.0 (101.7)
Planetaries (Total)	56.0 (14.8)	56.0 (14.8)
Differential	60.0 (15.8)	60.0 (15.8)
Front Ride Strut (Each)	14.0 (3.7)	14.0 (3.7)
Rear Ride Strut (Each)	17.0 (4.5)	17.0 (4.5)
Power Take Off	4.0 (1.0)	4.0 (1.0)

TR70

TR100

TR100DD

	Longitudinal 'V' type floor with integral transverse box-section stiffeners. The body is exhaust heated and rests on resilient impact absorption pads		
	Are high hardness Hardox (360-440BHN) abrasion resistant steel of yield strength 1 000 MPa (145 000 lbf/in ²)		
	19 (0.75)	19.0 (0.75)	19.0 (0.75)
	10 (0.39)	10.0 (0.39)	10.0 (0.39)
	10 (0.39)	10.0 (0.39)	10.0 (0.39)
	29.0 (38.0)	41.6 (54.4)	41.6 (54.4)
	41.5 (54.3)	55.5 (72.6)	55.5 (72.6)

	Two body hoist cylinders are mounted between the frame rails. Cylinders are two-stage with power down in the second stage. Float to chassis and over-centre kick-over control.		
	190 (2750)	190 (2750)	190 (2750)
	365 (97) @ 2100	365 (97) @ 2100	365 (97) @ 2100
	13	16.3	16.3
	11.5	18	18

	litres (US Gal.)	litres (US Gal.)	litres (US Gal.)
	33.0 (8.7)	134.0 (35.4)	108.0 (28.5)
	85 (22.5)	100.0 (26.0)	100.0 (26.0)
	236.0 (62.3)	304.0 (80.3)	276.0 (73.0)
	938.0 (248.0)	1275.0 (336.8)	1275.0 (336.8)
	61.0 (16.0)	61.0 (16.1)	61.0 (16.1)
	92.0 (24.3)	72.0 (19.0)	72.0 (19.0)
	258.0 (68.0)	297.0 (78.5)	297.0 (78.5)
	432.0 (114.0)	557.0 (147.1)	557.0 (147.1)
	43.0 (11.4)	57.0 (15.1)	57.0 (15.1)
	52.0 (13.7)	61.0 (16.1)	61.0 (16.1)
	25.0 (6.6)	27.0 (7.1)	27.0 (7.1)
	21.0 (5.5)	18.0 (4.8)	18.0 (4.8)
	4.0 (1.0)	1.5 (0.4)	1.5 (0.4)

DIMENSIONS in mm (ft-in)

	TR45	TR60	TR70	TR100	TR100DD
A	4630 (15-2)	4980 (16-4)	5290 (17-4)	5935 (19-6)	5935 (19-6)
B	4370 (14-4)	4630 (15-2)	4940 (16-2)	4825 (15-10)	4825 (15-10)
C	585 (1-11)	660 (2-2)	685 (2-3)	815 (2-8)	815 (2-8)
D	2665 (8-9)	2580 (8-5)	2970 (9-9)	2945 (9-8)	2945 (9-8)
E	3325 (10-11)	3320 (10-11)	3660 (12-0)	3760 (12-4)	3760 (12-4)
F	3985 (13-10)	4060 (13-4)	4420 (14-6)	4570 (15-10)	4570 (15-10)
G	4 135 (13-7)	N/A	N/A	4700 (15-5)	4700 (15-5)
H	4245 (13-11)	4440 (14-7)	4570 (15-0)	4850 (15-11)	4850 (15-11)
I	4520 (14-10)	4820 (15-10)	N/A	5235 (17-2)	5235 (17-2)
J	1195 (3-11)	1425 (4-8)	1536 (5-0)	1635 (5-4)	1635 (5-4)
K	810 (2-8)	950 (3-1)	1080 (3-6)	1220 (4-0)	1220 (4-0)
L	450 (1-6)	600 (2-0)	600 (2-0)	755 (2-7)	755 (2-7)
M	1520 (5-0)	1380 (4-6)	1500 (4-11)	1755 (5-9)	1755 (5-9)
N	2710 (8-11)	2900 (9-6)	2995 (9-10)	3420 (11-3)	3420 (11-3)
O	4000 (13-1)	4450 (14-7)	4445 (14-7)	5080 (16-8)	5080 (16-8)
P	4240 (13-11)	N/A	N/A	N/A	N/A

WEIGHTS

	TR45		TR60		TR70		TR100		TR100DD	
Standard Unit	kg	lb	kg	lb	kg	lb	kg	lb	kg	lb
Chassis with hoists	27,835	61,365	30,600	67,460	36,190	79,780	53,240	117,375	51,980	114,595
Body Standard	9300	20,500	10,650	23,480	11,500	25,350	15,020	33,115	15,020	33,115
Net weight	37,135	81,870	41,250	90,940	47,690	105,140	68,260	150,490	67,000	147,710
Maximum payload	40,825	90,000	54,430	120,000	65,000	143,300	90,720	200,000	90,720	200,000
Maximum gross weight*	77,960	171,870	95,680	210,940	112,690	248,440	158,980	350,490	157,720	347,710
Weight distribution (axles)	FRT	REAR	FRT	REAR	FRT	REAR	FRT	REAR	FRT	REAR
Empty	49%	51%	48%	52%	50%	50%	49%	51%	49%	51%
Loaded	34%	66%	34%	66%	34%	66%	34%	66%	34%	66%

N/A – not applicable.* Maximum permissible gross vehicle weight with options, attachments, full fuel tank and payload.

	TR45	TR60	TR70	TR100	TR100DD
Q	3800 (12-6)	4270 (14-0)	4280 (14-0)	5150 (16-11)	5150 (16-11)
Q+1	4060 (13-4)	4470 (14-8)	4940 (16-2)	N/A	N/A
R	3530 (11-7)	3950 (12-11)	3940 (12-11)	4730 (15-6)	4730 (15-6)
S	8700 (28-7)	9130 (29-11)	9905 (32-6)	10,802 (35-6)	10,896 (35-9)
T	2410 (7-11)	2600 (8-6)	2945 (9-8)	3100 (10-2)	3100 (10-2)
U	3940 (12-11)	4170 (13-8)	4470 (14-8)	4570 (15-0)	4570 (15-0)
V	2350 (7-9)	2360 (7-9)	2490 (13-9)	3150 (10-40)	3150 (10-40)
W	3855 (12-8)	3970 (13-0)	4190 (13-9)	4575 (15-0)	4575 (15-0)
X	7417 (24-4)	7750 (25-5)	8380 (27-6)	8640 (28-4)	8640 (28-4)
Y	5485 (18-0)	6000 (19-8)	6580 (21-7)	6880 (22-7)	6880 (22-7)
Z	4700 (15-50)	5050 (16-7)	6200 (20-4)	6080 (19-11)	6080 (19-11)
Z+1	58 degrees	58 degrees	58 degrees	58 degrees	58 degrees
Z+2	7645 (25-1)	8050 (26-5)	8380 (27-6)	8960 (29-5)	8960 (29-5)
Z+3	430 (1-5)	500 (1-8)	N/A	510 (1-8)	510 (1-8)
Z+4	3425 (11-3)	3680 (12-1)	3785 (12-5)	4445 (14-7)	4445 (14-7)
Z+5	585 (1-11)	580 (1-6)	460 (1-6)	660 (2-2)	660 (2-2)

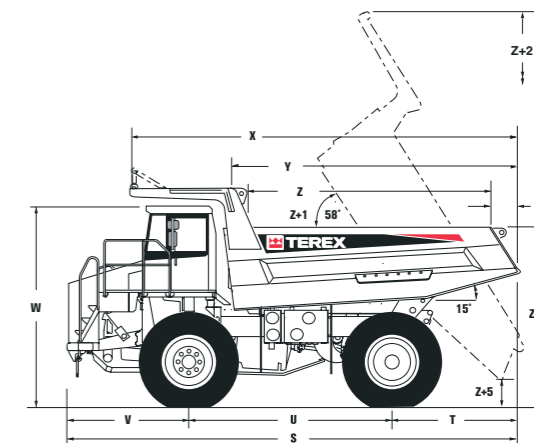
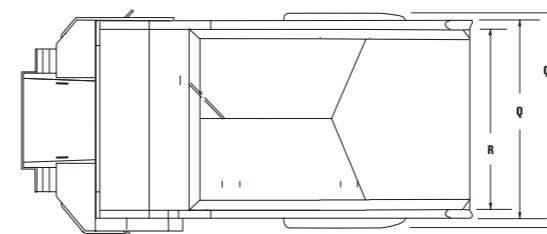
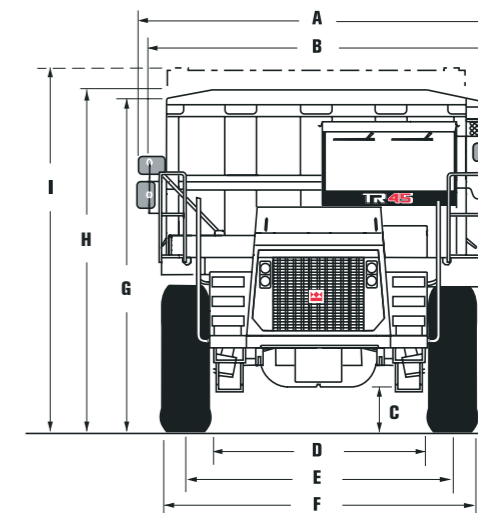
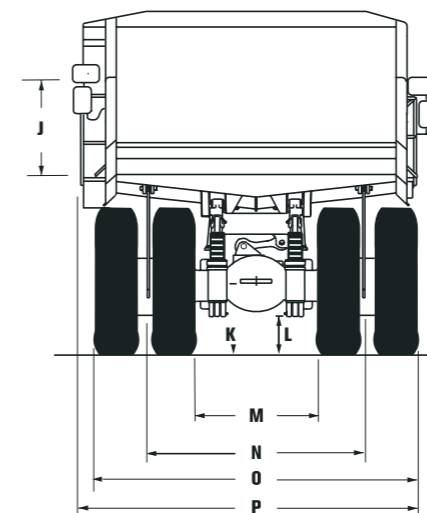

PERFORMANCE DATA

Graphs based on 2% Rolling Resistance

TR45

GRADEABILITY

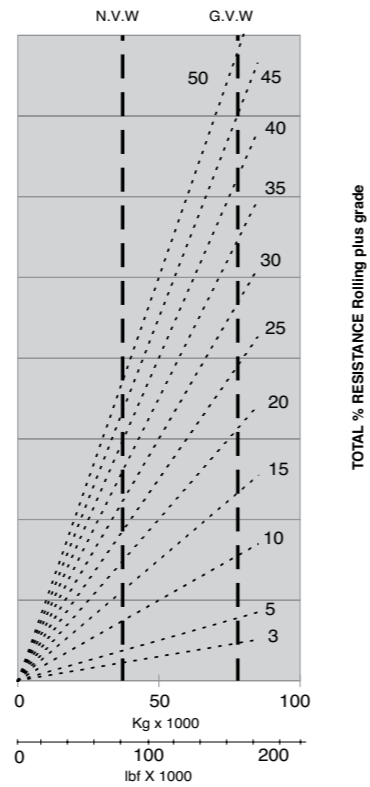
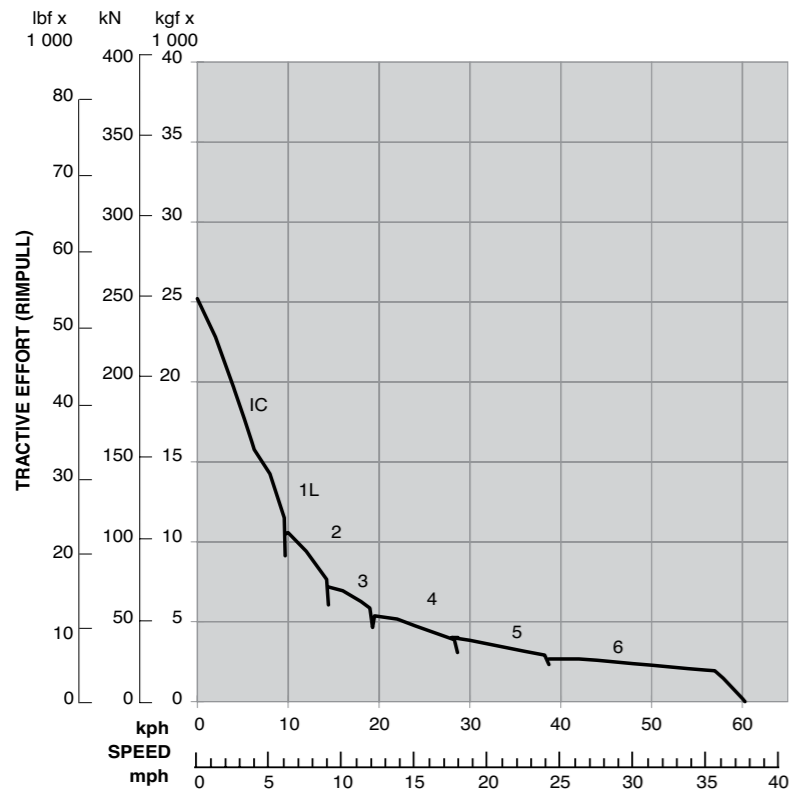

TOTAL % RESISTANCE Rolling plus grade

RETARDATION

Instructions: From intersection of vehicle weight with percentage resistance line read across to determine maximum gear attainable, and then downwards for vehicle speed.

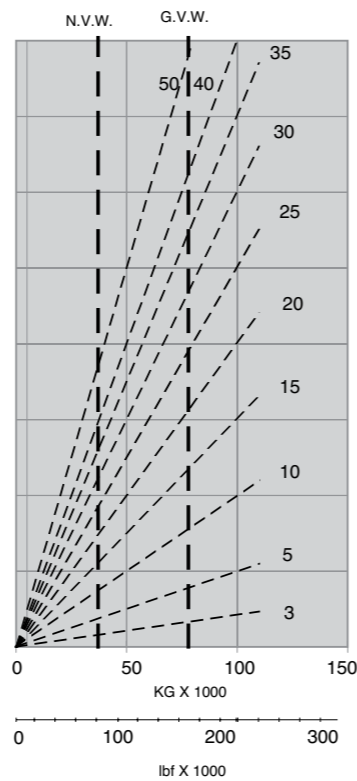
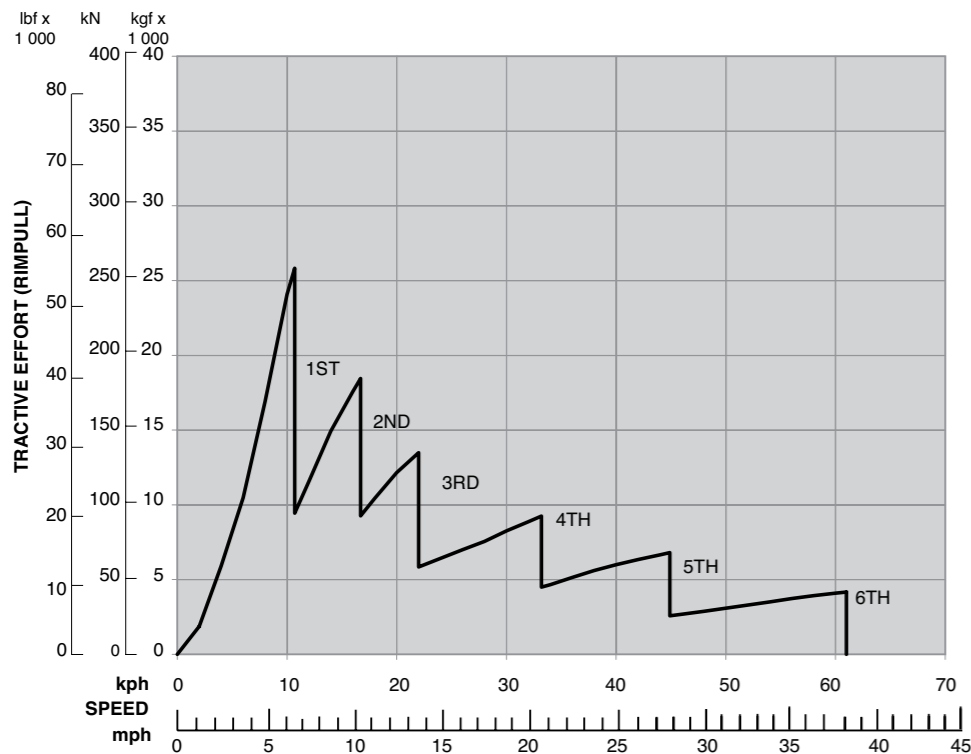

TOTAL % RESISTANCE Rolling minus Grade

PERFORMANCE DATA

Graphs based on 2% Rolling Resistance

TR60

GRADEABILITY

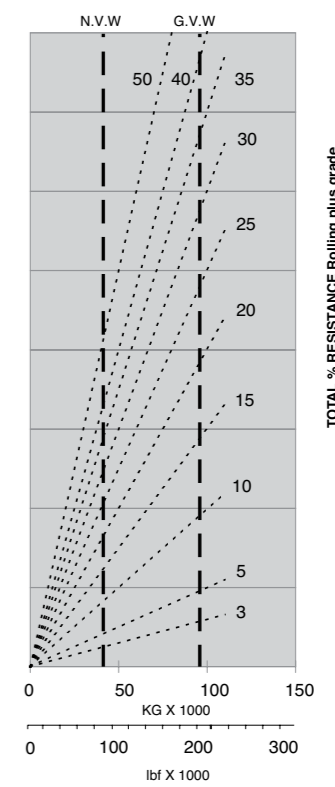
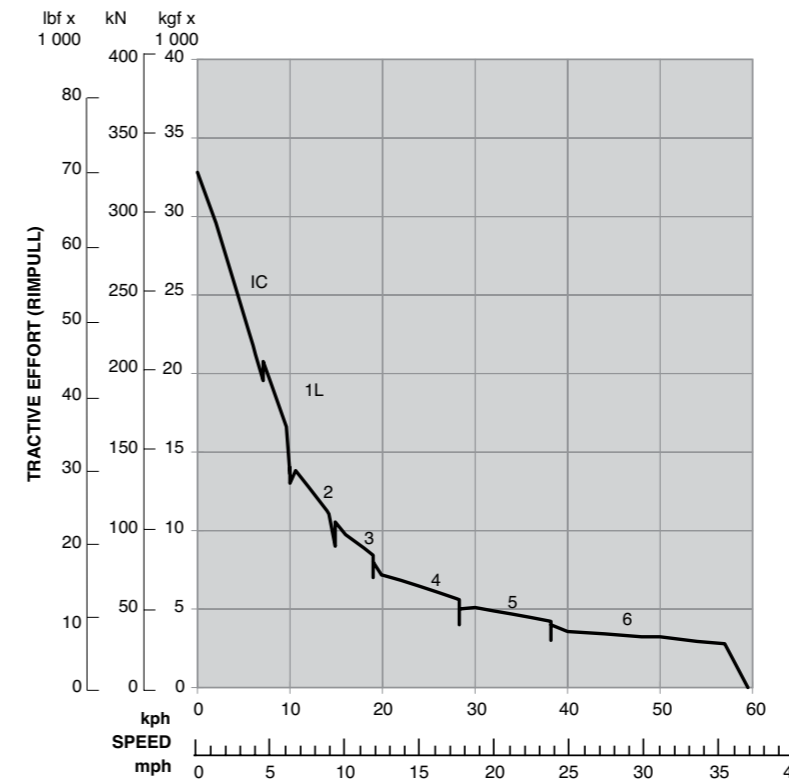

TOTAL % RESISTANCE Rolling plus grade

RETARDATION

Instructions: From intersection of vehicle weight with percentage resistance line read across to determine maximum gear attainable, and then downwards for vehicle speed.

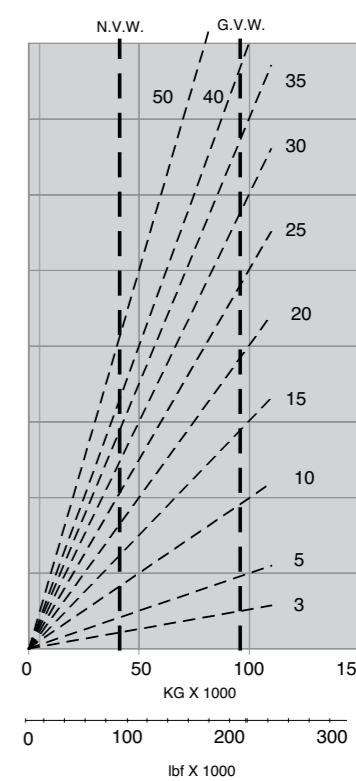
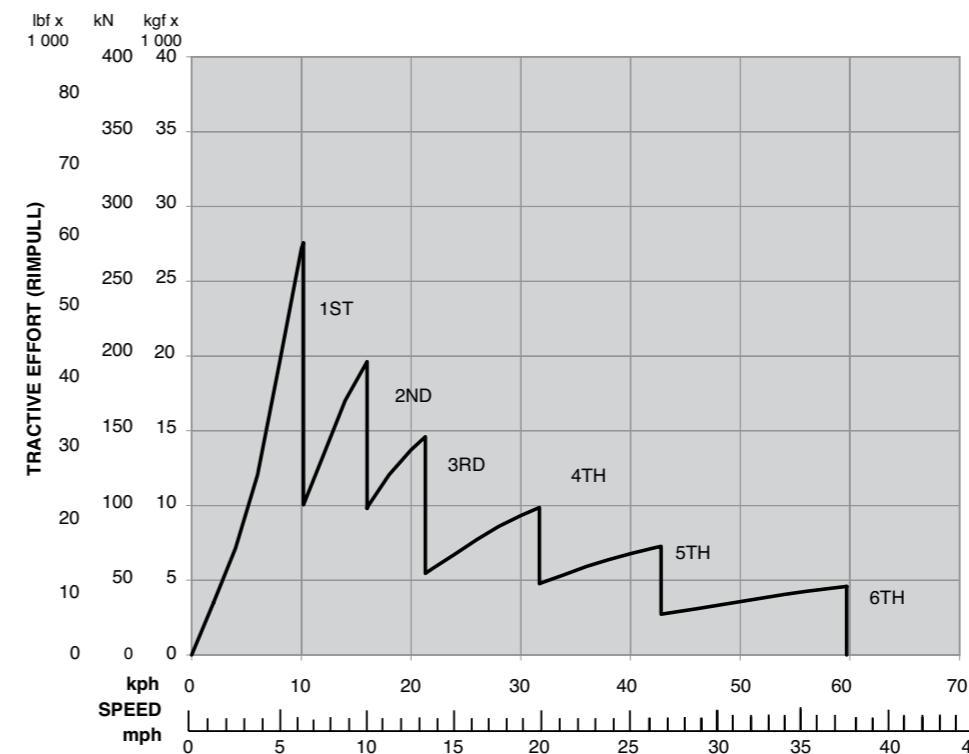

TOTAL % RESISTANCE Rolling plus grade

PERFORMANCE DATA

Graphs based on 2% Rolling Resistance

TR70

GRADEABILITY

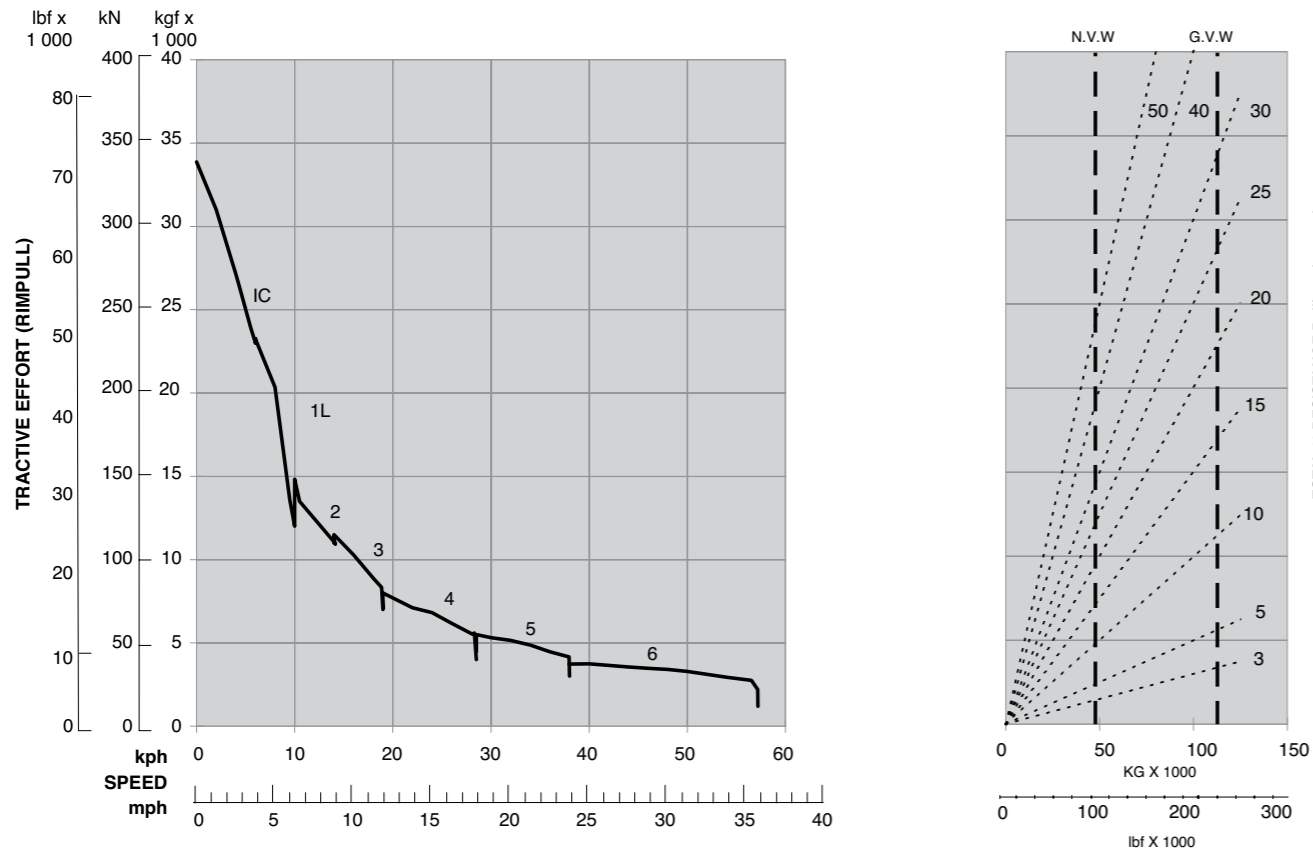

22

PERFORMANCE DATA

Graphs based on 2% Rolling Resistance

TR100

GRADEABILITY

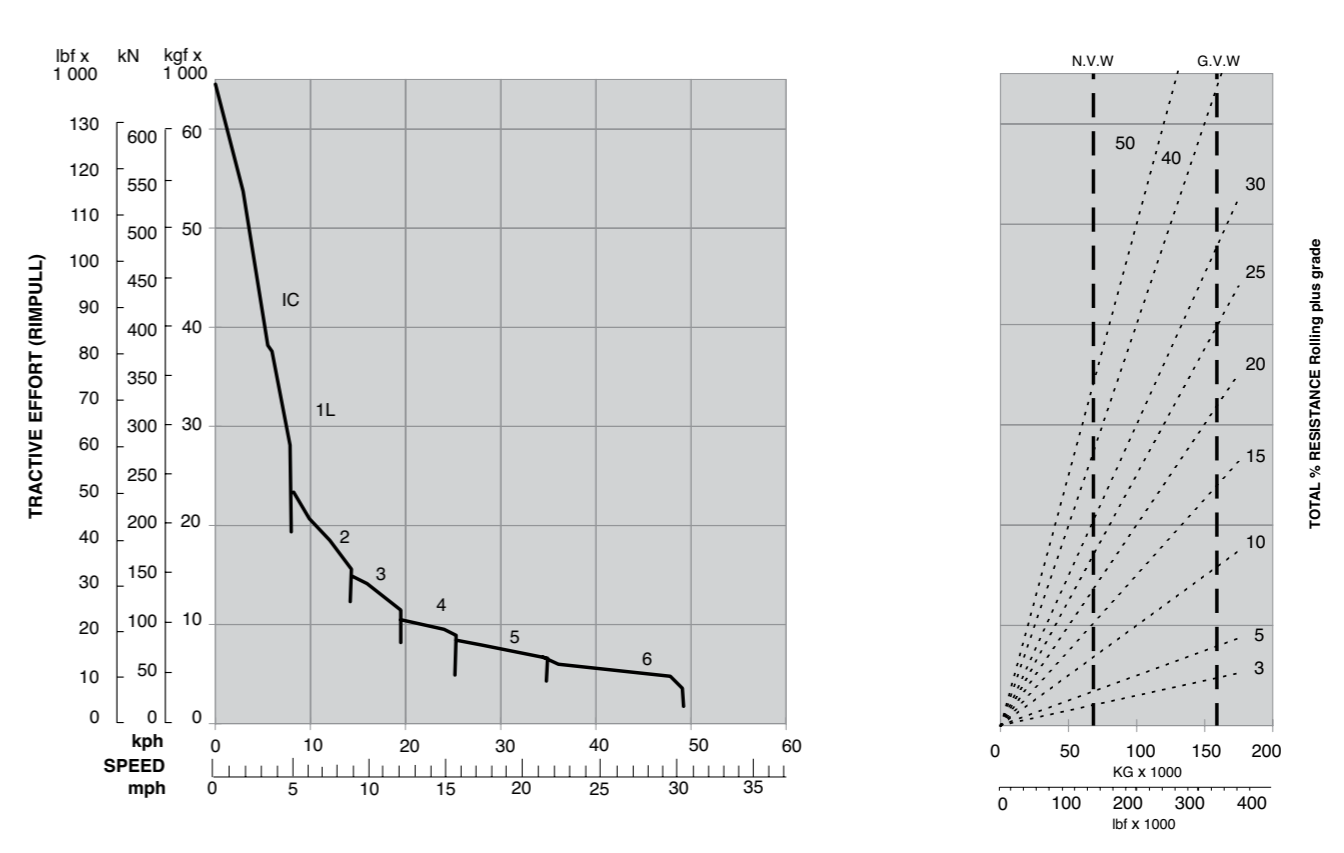

23

RETARDATION

Instructions: From intersection of vehicle weight with percentage resistance line read across to determine maximum gear attainable, and then downwards for vehicle speed.

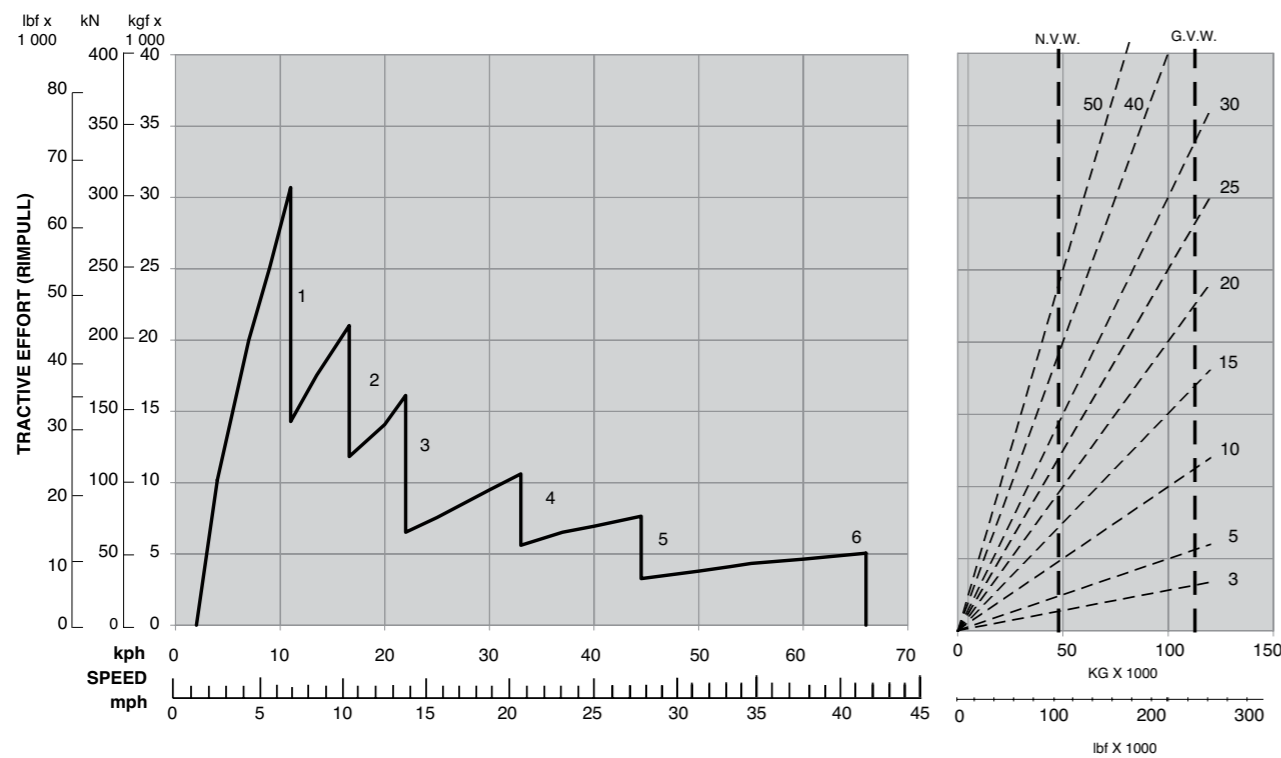

RETARDATION

Instructions: From intersection of vehicle weight with percentage resistance line read across to determine maximum gear attainable, and then downwards for vehicle speed.

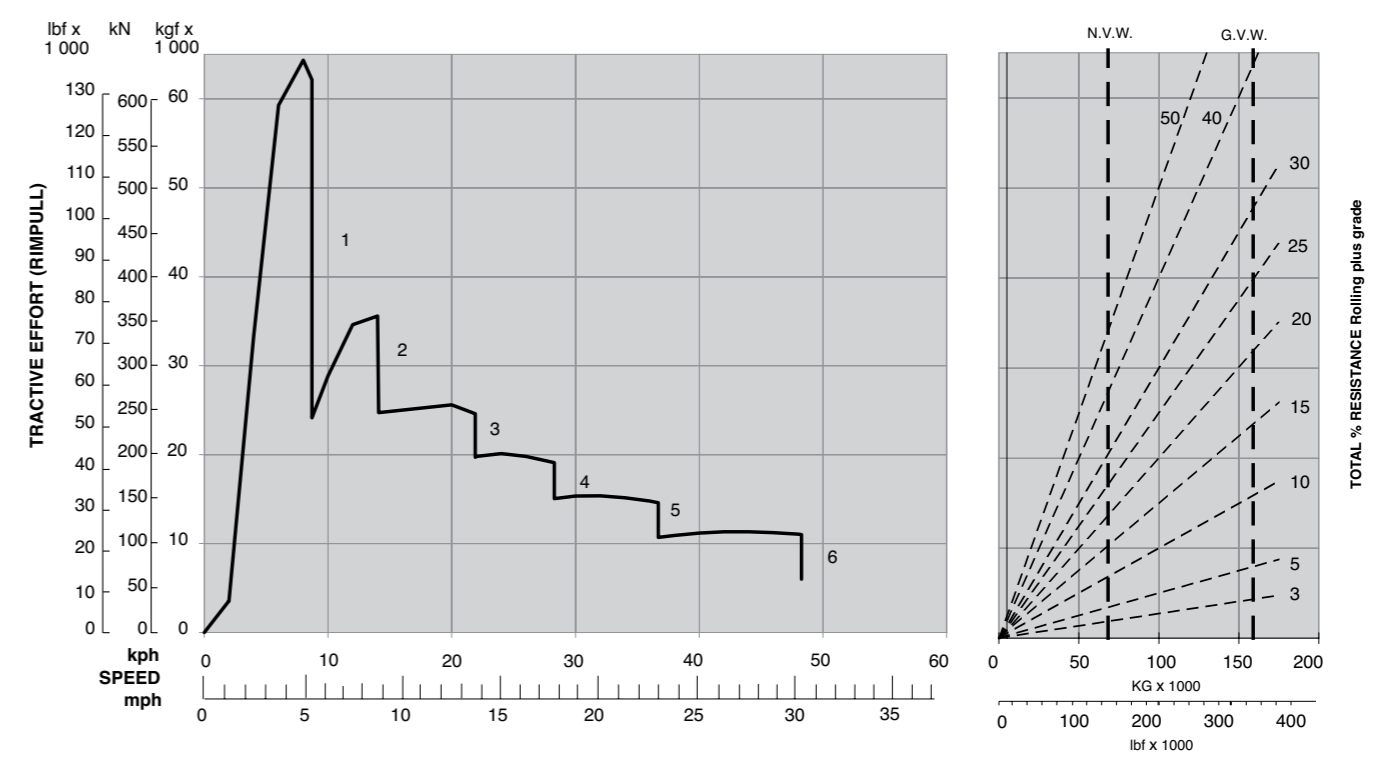

PERFORMANCE DATA

Graphs based on 2% Rolling Resistance

TR100DD

GRADEABILITY

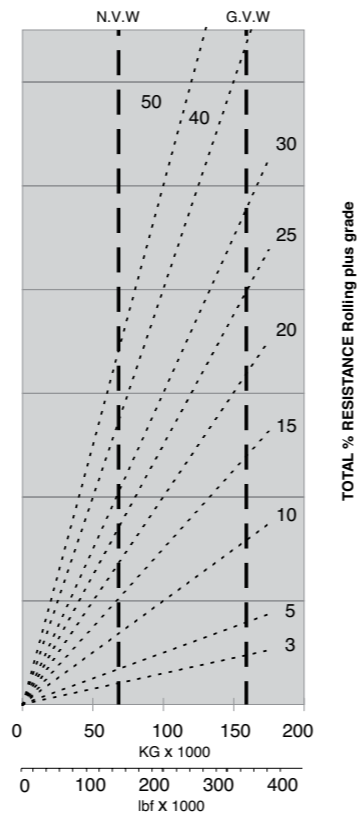
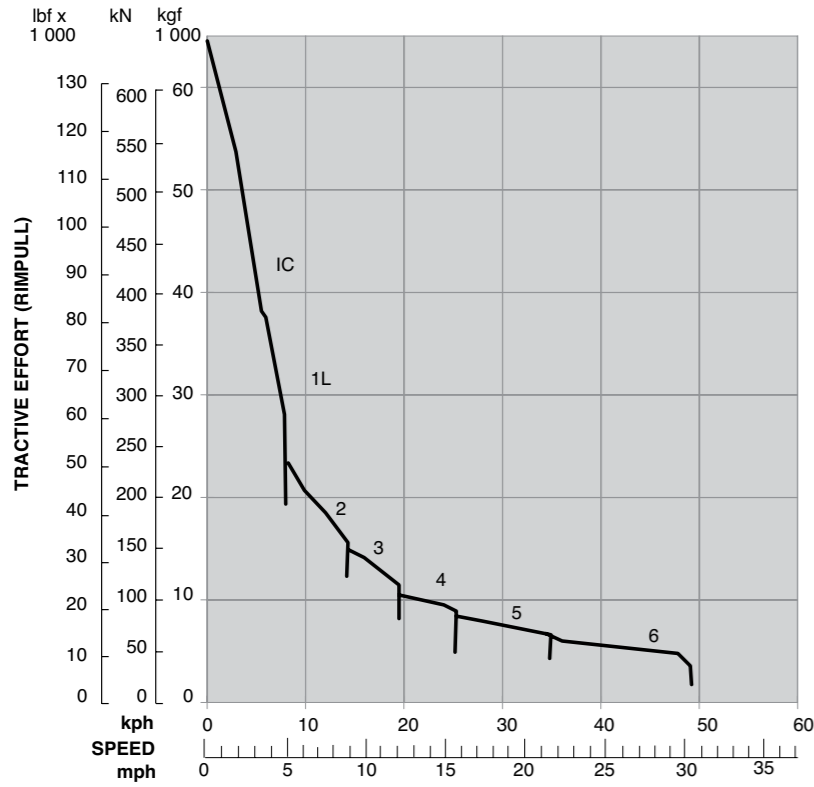

RETARDATION

Instructions: From intersection of vehicle weight with percentage resistance line read across to determine maximum gear attainable, and then downwards for vehicle speed.

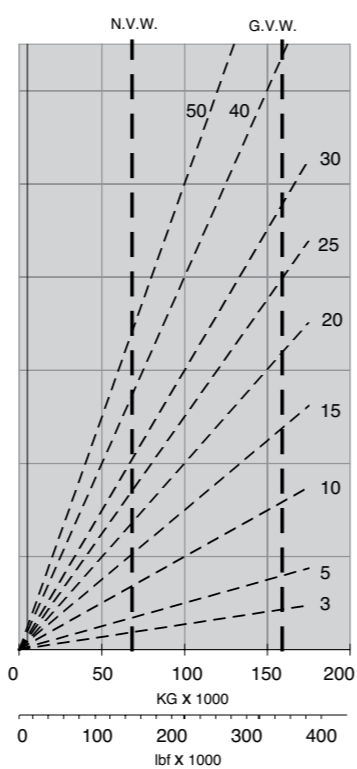
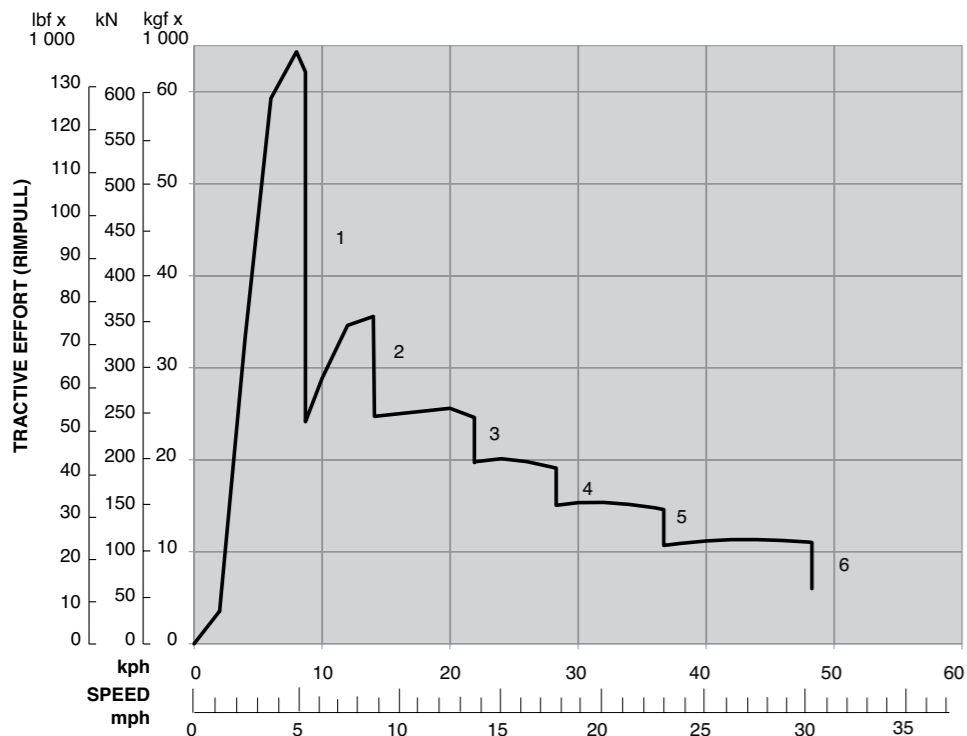

STANDARD SPECIFICATION OPERATOR ENVIRONMENT

	TR 45	TR 60	TR 70	TR 100	TR 100DD
2 Doors lights	✓	✓	✓	✓	✓
Air Conditioning	✓	✓	✓	✓	✓
Body Hoist Control, Servo Assisted	✓	✓	✓	✓	✓
CD/Radio Player	✓	✓	✓	✓	✓
Cup Holder	✓	✓	✓	✓	✓
FOPS Protection, ISO 3449/SAE J231	✓	✓	✓	✓	✓
Heater/Demistor	✓	✓	✓	✓	✓
Horn	✓	✓	✓	✓	✓
Insulation, Thermal and Acoustic	✓	✓	✓	✓	✓
Interior Light	✓	✓	✓	✓	✓
Mirrors	✓	✓	✓	✓	✓
Power Port, 24V & 12V	✓	✓	✓	✓	✓
Power Window (LHS)	✓	✓	✓	✓	✓
Reverse Camera With Colour Monitor	✓	✓	✓	✓	✓
ROPS Protection (Body Cabguard), ISO 3471/SAE J1040	✓	✓	✓	✓	✓
Seat, Operator, Air Suspension	✓	✓	✓	✓	✓
Seat Belt, Operator 4-Point Harness	✓	✓	✓	✓	✓
Seat, Trainer	✓	✓	✓	✓	✓
Steering Wheel, Padded with Tilt	✓	✓	✓	✓	✓
Storage Compartment	✓	✓	✓	✓	✓
Sun Visor	✓	✓	✓	✓	✓
Tinted Glass	✓	✓	✓	✓	✓
Wiper And Washer, Windscreen	✓	✓	✓	✓	✓
Gauges	✓	✓	✓	✓	✓
Coolant Temperature	✓	✓	✓	✓	✓
Engine Oil Pressure	✓	✓	✓	✓	✓
Fuel Level	✓	✓	✓	✓	✓
Hourmeter	✓	✓	✓	✓	✓
Odometer	✓	✓	✓	✓	✓
Speedometer	✓	✓	✓	✓	✓
Tachometer	✓	✓	✓	✓	✓
Transmission Oil Temperature	✓	✓	✓	✓	✓

	TR 45	TR 60	TR 70	TR 100	TR 100DD
Warning indicator lights					
Air Cleaner Restriction	✓	✓	✓	✓	✓
Air Filter Restriction Indicator	✓	✓	✓	✓	✓
Alternator Charging	✓	✓	✓	✓	✓
Body Up	✓	✓	✓	✓	✓
Brake Cooling Oil Temperature, High	✓	✓	✓	✓	✓
Brakes Front, Low Pressure	✓	✓	✓	✓	✓
Brakes Rear, Low Pressure	✓	✓	✓	✓	✓
Direction Indicator	✓	✓	✓	✓	✓
Engine Check	✓	✓	✓	✓	✓
Engine Coolant Level	✓	✓	✓	✓	✓
Engine Coolant Temperature	✓	✓	N/A	N/A	N/A
Engine Maintenance	✓	✓	✓	✓	✓
Engine Oil Pressure	✓	✓	✓	✓	✓
Engine Overspeed	✓	✓	✓	✓	✓
Engine Stop	✓	✓	✓	✓	✓
Headlight Main Beam	✓	✓	✓	✓	✓
In-Converter	✓	✓	✓	✓	✓
Parking Brake	✓	✓	✓	✓	✓
Retarder Active	✓	✓	✓	✓	✓
Steering and Brake Tank, Low Oil Level	✓	✓	✓	✓	✓
Steering Filter Restriction	✓	✓	✓	✓	✓
Steering, Low Pressure	✓	✓	✓	✓	✓
Transmission Check	✓	✓	✓	✓	✓
Transmission Oil Filter Restriction	✓	✓	✓	✓	✓
Transmission Oil Temperature, High	✓	✓	✓	✓	✓
Audible Alarms					
Brakes Front, Low Pressure	✓	✓	✓	✓	✓
Brakes Rear, Low Pressure	✓	✓	✓	✓	✓
Steering, Low Pressure	✓	✓	✓	✓	✓

STANDARD SPECIFICATION OPERATOR ENVIRONMENT

	TR 45	TR 60	TR 70	TR 100	TR 100DD
Engine					
Charge Air Cooler	✓	✓	✓	✓	✓
Air Cleaner with Precleaner	✓	✓	✓	✓	✓
Direct Drive Fan	✓	✓	✓	✓	✓
Engine Compression Release Brake, 2 Stage	N/A	N/A	N/A	N/A	N/A
Fuel Filter/Water Separator	✓	✓	✓	✓	✓
Sump Guard	✓	✓	✓	✓	✓
Transmission					
Adaptive Shift Technology	N/A	N/A	N/A	N/A	N/A
Body-Up Reverse Interlock	✓	✓	✓	✓	✓
Body-Up Shift Inhibitor	✓	✓	✓	✓	✓
Downshift Inhibitor	✓	✓	✓	✓	✓
Filter Restriction Shift Inhibitor	✓	✓	✓	✓	✓
Hydraulic Retarder	✓	✓	✓	✓	✓
Neutral Start Interlock	✓	✓	✓	✓	✓
Power and Economy Mode Selection	✓	✓	✓	✓	✓
Shift Energy Management	✓	✓	✓	✓	✓
Stall Check and Limp Home Selection	✓	✓	✓	✓	✓
Sump Guard	✓	✓	✓	✓	✓
Braking System					
50% Front Brake Pressure Reducer	opt	opt	opt	✓	✓
Air Actuated Dual Circuits	N/A	N/A	N/A	N/A	N/A
Brake Retarder (Rear)	✓	✓	✓	✓	✓
Drum Brakes (Front & Rear)	N/A	N/A	N/A	N/A	N/A
Front Dry Disc Brakes	✓	✓	✓	✓	✓
Hydraulically Actuated Dual Circuits	✓	✓	✓	✓	✓
OCDB Oil Cooler	✓	✓	✓	✓	✓
Oil-Cooled Multiple-Disc (Rear)	✓	✓	✓	✓	✓
Park Brake Integral To Rear Brake Pack	✓	✓	✓	✓	✓

ELECTRICAL

	TR 45	TR 60	TR 70	TR 100	TR 100DD
Alternator, 70A	✓	✓	✓	✓	✓
Batteries, 2 x 12V, 165Ah	✓	✓	✓	N/A	N/A
Batteries, 4 x 12V, 210Ah	N/A	N/A	N/A	✓	✓
Battery Master Switch, Electrically Operated	✓	✓	✓	✓	✓
Direction Indicators And Hazard Warning	✓	✓	✓	✓	✓
Headlights	✓	✓	✓	✓	✓
In-Cab Diagnostics, Engine/Transmission	✓	✓	✓	✓	✓
Reverse Alarm	✓	✓	✓	✓	✓
Reverse Lights (Twin)	N/A	N/A	✓	✓	✓
Side, Tail, Stop and Reverse Lightsk	✓	✓	✓	✓	✓
Side, Tail, Stop Lights (Led)	N/A	N/A	✓	✓	✓

BODY

	TR 45	TR 60	TR 70	TR 100	TR 100DD
Body Down Indicator	✓	✓	✓	✓	✓
Exhaust Heated	✓	✓	✓	✓	✓
Mud Flaps	✓	✓	✓	✓	✓
Operator Guard - LHS	✓	✓	✓	✓	✓
Operator Guard - RHS	N/A	✓	✓	✓	✓
Rock Ejectors	✓	✓	✓	✓	✓
Safety Locking Pins	✓	✓	✓	✓	✓
Tyre Guards	✓	✓	✓	✓	✓

OTHER

	TR 45	TR 60	TR 70	TR 100	TR 100DD
Diagnostic Pressure Test Points	✓	✓	✓	✓	✓
Exhaust Muffler	✓	✓	✓	✓	✓
Handrails on Fenders	✓	✓	✓	✓	✓
Tow Points, Front and Rear	✓	✓	✓	✓	✓

N/A - not applicable
opt - available as option
✓ - standard fit

OPTIONS

	TR 45	TR 60	TR 70	TR 100	TR 100DD
Alternator, 100A	✓	✓	✓	✓	✓
Arctic Hose Kit	N/A	N/A	N/A	✓	✓
Auto Lubrication System	✓	✓	✓	✓	✓
Auxiliary Jump-Start Receptacle	✓	✓	✓	✓	✓
Beacon - Flashing	✓	✓	✓	✓	✓
Beacon - Rotating	✓	✓	✓	✓	✓
Body Liner Plates	✓	✓	✓	✓	✓
Body Liner Plates & Top Rail Protectors	N/A	N/A	N/A	✓	✓
Body Side Extensions - 200mm	✓	✓	✓	✓	✓
Body Spill Guard	✓	✓	✓	✓	✓
Body Up Buzzer	✓	✓	✓	✓	✓
Camera System - RHS View	N/A	N/A	N/A	✓	✓
Deluxe Seat Option - Heavy Duty	✓	✓	✓	✓	✓
Differential - Traction Bias	N/A	N/A	N/A	✓	✓
Engine Overspeed Protection System	N/A	✓	✓	✓	✓
Fast Fuel - Bumper Mounted	N/A	N/A	N/A	✓	✓
Fast Fuel Installation	✓	✓	✓	✓	✓
Fire Suppression System	✓	✓	✓	✓	✓
Front Brake Pressure Reduction System	✓	✓	✓	✓	✓
Full Time Exhaust	N/A	N/A	✓	✓	✓
Ground Level Isolation Security Box	✓	✓	✓	✓	✓

N/A - not applicable
opt - available as option
✓ - standard fit
Note for options not listed please contact your Terex sales representative.

	TR 45	TR 60	TR 70	TR 100	TR 100DD
Ground Level Isolation Switch	✓	✓	✓	✓	✓
Hand Tool Kit	✓	✓	✓	✓	✓
Headlights - HiD	N/A	N/A	N/A	✓	✓
Mirrors - Heated	N/A	N/A	N/A	✓	✓
Oil Drain Kit	✓	✓	✓	✓	✓
Payload Monitoring System	✓	✓	✓	✓	✓
Planetary - Alternate Ratio (10.5:1) & Top Rail Protectors	N/A	N/A	N/A	✓	✓
Rear Light Assembly-LED	✓	✓	std	std	std
Rear Light Assembly-LED with Broadband Reverse Alarm	✓	✓	✓	✓	✓
Reverse Light - Flashing	✓	✓	✓	✓	✓
Rockford Fan Clutch	N/A	N/A	N/A	✓	N/A
Seat Belt - Lap	✓	✓	✓	✓	✓
Service Lighting Kit-LED	N/A	N/A	N/A	✓	✓
Start Interlock - Parkbrake	✓	✓	✓	✓	✓
Step Lighting Kit	✓	✓	✓	✓	✓
Step Mudflaps	N/A	✓	✓	✓	✓
TR45 to TR40 Conversion - Body 36mt 24m ³	✓	N/A	N/A	N/A	N/A
Worklight Installation (Front x 2)	N/A	N/A	N/A	✓	✓



www.terextrucks.com

Effective Date: July 2015. Product specifications and prices are subject to change without notice or obligation. The photographs and/or drawings in this document are for illustrative purposes only. Refer to the appropriate Operator's Manual for instructions on the proper use of this equipment. Failure to follow the appropriate Operator's Manual when using our equipment or to otherwise act irresponsibly may result in serious injury or death. The only warranty applicable to our equipment is the standard written warranty applicable to the particular product and sale and Terex Trucks makes no other warranty, express or implied. © 2015 Terex Trucks.

Ref. no.: TTRDTEN

Terex Equipment Ltd
Newhouse Industrial Estate, Motherwell, ML1 5RY
Tel: +44 (0) 1698 732121 Fax : +44 (0) 1698 734046
www.terextrucks.com



A DIVISION OF VOLVO CONSTRUCTION EQUIPMENT