



**DD Series**







DD Series

DD-14S/DD-16/DD-20 2.07 m  
 DD-24/DD-30/DD-28HF/DD-34HF/CR-24/CR-30 2.56 m

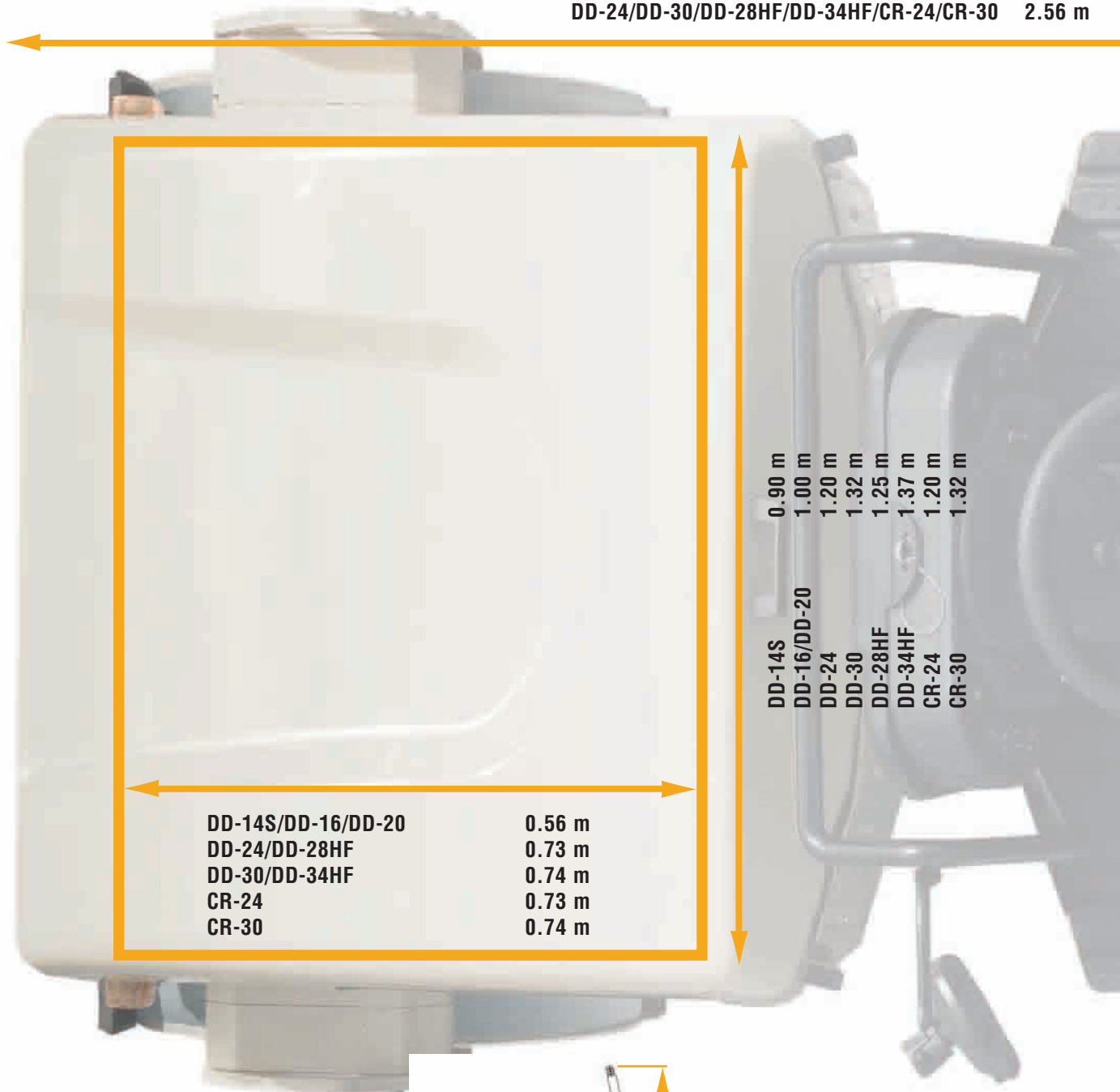

DD-14S/DD-16/DD-20	0.56 m
DD-24/DD-28HF	0.73 m
DD-30/DD-34HF	0.74 m
CR-24	0.73 m
CR-30	0.74 m

DD-14S	0.90 m
DD-16/DD-20	1.00 m
DD-24	1.20 m
DD-30	1.32 m
DD-28HF	1.25 m
DD-34HF	1.37 m
CR-24	1.20 m
CR-30	1.32 m

DD-14S/DD-16 DD-20	1.53 m
DD-24/DD-30 DD-28HF/DD-34HF	1.83 m



DD-14S/DD-16 DD-20	1.40 m
-----------------------	--------

DD-24/DD-30 DD-28HF/DD-34HF	1.73 m
--------------------------------	--------

DD-14S/DD-16 DD-20	2.53 m
DD-24/DD-30 DD-28HF/DD-34HF	2.68 m

# DURAPAC Series ULTRAPAC Series

DURAPAC	
DD-14S	1.55 t
DD-16	1.65 t
DD-20	2.06 t
DD-24	2.90 t
DD-30	3.14 t

CR-24	2.58 t
CR-30	2.99 t

ULTRAPAC	
DD-28HF	3.11 t
DD-34HF	3.78 t



DD-14S/DD-16  
KUBOTA D722  
12.6kW 16.9hp

DD-20  
KUBOTA D722-B  
14.9kW 20hp

DD-24/DD-30  
CR-24/CR-30  
KUBOTA V12203M  
32.8 kW 44 hp

DD-28HF/DD-34HF  
KUBOTA V2203M  
32.8 kW 44 hp

DD-14S	1.02 m
DD-16/DD-20	1.09 m
DD-24	1.31 m
DD-30	1.44 m
DD-28HF	1.31 m
DD-34HF	1.44 m
CR-24	1.31m
CR-30	1.44m

CR-24/CR-30  
1.84 m



CR-24/CR-30  
2.73 m

CR-24/CR-30 1.74 m



DD-14S 197 lit.

DD-16

DD-20

DD-24 299 lit.

DD-30

DD-28HF

DD-34HF





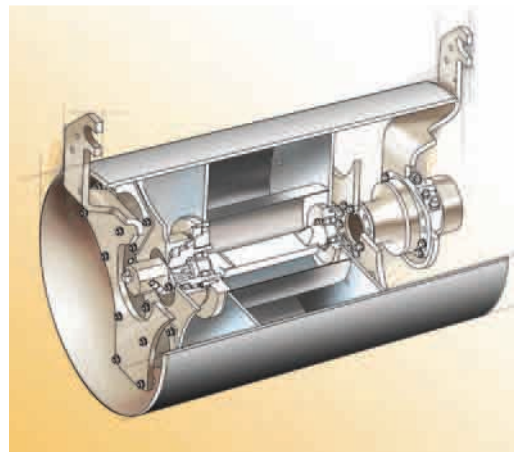

CR-24

CR-30



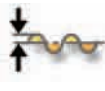

DD-14S	1.84 m
DD-16/DD-20	1.80 m
DD-24	2.62 m
DD-30	2.56 m
DD-28HF	2.60 m
DD-34HF	2.53 m
CR-24	2.64 m
CR-30	2.58 m

												
	Kg		Kg / cm		Hz		kN		mm		Ø mm t mm	
DD-14 S	710	835	7.50 / 9.28		66.7		15.57		0.37		560 12	
DD-16	741	908	7.41 / 9.08		66.7		17.79		0.40		560 12	
DD-20	914	1141	9.14 / 11.41		69.0		19.10		0.40		560 12	
DD-24	1332	1562	11.22 / 13.02		66.7		39.41		0.51		732 12	
DD-28 HF	1412	1695	11.30 / 13.56		70.0		36.00		0.38		736 14	
DD-30	1454	1682	11.02 / 12.74		66.7		33.00		0.33		741 12	
DD-34 HF	1748	2032	12.72 / 14.78		70.0		36.00		0.33		740 16	
CR-24	1325	1254	11.04 / -		66.7		32.00		0.41		732 12	
CR-30	1508	1477	11.19 / -		66.7		33.00		0.34		741 12	

Technische Änderungen vorbehalten.  
 Specifications are subject to alteration without prior notice.  
 Sous réserve de modifications techniques.  
 Nos reservamos el derecho de realizar modificaciones técnicas sin previo aviso.

© 2005 IR-ABG Form # 19- 0705 CPN 80626047

 **Ingersoll-Rand**

**ABG**

Allgemeine Baumaschinen-  
 Gesellschaft mbH  
 Kuhbrückenstraße 18  
 31785 Hameln  
[www.ir-abg.com](http://www.ir-abg.com)

tel. +49 (0) 5151/ 209-0

fax +49 (0) 5151/ 209-204