

37,830 – 42,760 lb, 117 hp

VOLVO EXCAVATOR

EC160C



MORE CARE. BUILT IN.



VOLVO - A PARTNER TO TRUST.

Your machine and your word. The two things that matter most to the growth of your success. Trust the Volvo EC160C Excavator to help you keep both working for you. And because you can rely on Volvo uptime, you can keep moving – on to the next job. Its versatility is ideal for small-scale contractors or owner/operators. Perfect for general drainage, landscaping, footings and road maintenance, the Volvo EC160C is ready to be your partner. And with proven, industry-leading fuel economy and an enhanced Volvo Care Cab – this trusted partner will help you pay the bills everyday.

Your local partner around the globe

Since 1927, Volvo has earned a global reputation for providing complete solutions. Volvo is built on core values of quality, safety and environmental care. The extensive line of construction equipment is augmented by Volvo's commercial transport solutions, including buses and trucks. This global experience and expertise have led to the ongoing development of engines with the lowest fuel consumption in their class. Today, the tradition continues with Volvo C-Series Excavators – designed and built to the exacting standards that make each machine a trusted Volvo partner.

The protection of Volvo quality

Test the competitors – then test the Volvo EC160C. The difference is obvious: Volvo builds more care and quality throughout – from the well-built cab details to the reinforced service doors to the rigid, long-life undercarriage.

If you have ever owned or operated a Volvo Wheel Loader, Articulated Hauler or any one of our full scope of global equipment offerings, you know that Volvo stands for quality, comfort and safety. You can trust the Volvo EC160C Excavator to be the partner you can rely on – year after year.

Volvo innovates comfort – again

Volvo is known as an innovative leader in comfort. That's because Volvo listens to customers – and then intelligently uses technology and constant improvements to deliver. The EC160C carries on the tradition with a larger, more ergonomic work environment. Visibility is better. So are the seat, floor space and access to controls. Take command.

Better fuel economy: your edge

Volvo is also known for fuel efficiency. Once again, Volvo doesn't rest on reputation and the EC160C is set to remain the industry leader that gets the most out of each tank. Volvo: your most fuel-efficient option.

Ease into your application

From digging foundations and pools, landscaping and stump removal to pipe laying, loading and trenching, the versatile Volvo EC160C Excavator makes your work easier.

Strength and endurance

When you face brutal terrain and long workdays, it's nice to know your excavator is up to the challenge. The Volvo EC160C answers with proven booms and arms that have been designed and tested to live up to high Volvo standards. The Volvo EC160C Excavator will help you get the job done so you can move on to the next job – and the next pay check.



• Volvo: a sign of trust and quality.



• Intelligent command means greater profits.



• Reinforced boom/arm handles all the jobs.



• The perfect all-around machine gets it done.



• Efficient Volvo engine delivers high torque at very low RPMs.

- Reliable, reinforced boom and arm handles a variety of jobs with an ideal combination of capacity, reach and force.
- Volvo high-tech toughness puts you comfortably in command of greater profits.
- Powerful Volvo V-ACT engine delivers proven performance and industry-leading fuel efficiency through high torque at low revs.

VOLVO'S ENGINE LEADERSHIP SPANS LAND, SEA, SKY AND SPACE

As the world's largest manufacturer of 9-to-18-liter diesel engines, Volvo has unmatched expertise designing power systems that move the world. Volvo engines for Volvo Construction Equipment, Volvo

Aero, Volvo Buses, Volvo Penta and Volvo Trucks define productivity and fuel economy. Our performance has been honed on land, over the sea, across the sky and into space. Leading research and development

keeps all Volvo Group products at the forefront of productivity. So when we say Volvo engines are tested — and proven — you can believe it. Trust in it. It's the real advantage of Volvo Power.



IN COMMAND WITH COMFORT AND SAFETY.

Consider the Volvo EC160C your new office. It's where you'll be most of the day. It's where you'll get your work done. And because it's a Volvo, it's as comfortable and safe as it is productive. The industry-leading Volvo cab has been further improved. Ease into the seat and see how the well-placed controls and instruments put you in command. There's more space and more glass with less noise and less vibration. And with enhanced Volvo safety and environmental protection, peace-of-mind comes standard. Get the edge you need. Go to work with the Volvo EC160C.

Comfortable new cab eases fatigue

Volvo remains the innovative industry leader in comfort. The EC160C adjustable seat supports your whole body. Pedal positions are now shifted forward for more foot space. The cab is wider. Experience the right operating position with joystick and seat adjustments. To reduce fatigue and hazardous whole body vibration, Volvo has gone beyond emerging cab vibration regulations with an enhanced suspension system.

Greater visibility puts you in command

The new cab features expansive glazed surface areas. Operators told Volvo that upper visibility is important. Volvo listened. The roof hatch offers an expanded view during high-reach applications. The engine hood size and height has been reduced for better visibility to the rear. The gas strut assisted windshield opens with ease, while the smartly positioned windshield wiper cleans a wider area – including both upper corners. The easy-to-read LCD color monitor offers real-time information. The EC160C Volvo engine produces less noise and the pressurized, well-insulated cab blocks sound. The Volvo experience means greater production.

Electronic climate control

Intelligently going beyond automobile technology, the EC160C's high-tech electronic climate control system comforts your entire body with the highest capacity heating and cooling ventilation system available in the excavator industry.

A safe place to work

The new-design Volvo Care Cab, with operator protective structure provides security. Volvo's attention to ergonomics when designing controls and pedals ensures operator protection for safe, long-term use. An optional color rearview camera displaying on the LCD color monitor provides a safe view while swinging or traveling.

Anti-slip walk areas

Outside the cab, all steps and platforms feature quality anti-slip traction with punched steel plates for superior grip – even when wet or icy. The bolt-on plates feature recessed bolts for less risk of trip hazard.

More care for the environment

More than 95% of the machine materials are recyclable. External sound levels have been greatly reduced for fewer disturbances. The machine's exterior paint is lead-free. Safety – for the people and environment around you – has always been a cornerstone value of Volvo. You can trust Volvo to pay special attention to environmental protection.



• Experience the comfort of the suspension seat.



• Well-positioned monitor and controls.



• Greater floor space with ergonomic pedals.



• Industry's highest heating/cooling capacity with 14 vents.

- Expansive glass and clear sight lines provide outstanding all-around visibility with greater safety.
- Experience the adjustable, suspension seat and take command of the jobsite.
- All-new cab is larger and more comfortable with ergonomic controls and vibration dampening suspension – for all-day production.
- New, easy-to-read LCD color monitor and perfectly positioned controls put you in command.
- Expanded floor space and ergonomic travel pedals provide greater legroom and more room for work boots.
- Electronic climate control system distributes comfort evenly with 14 air vents and the highest capacity heating/cooling available in the excavator industry.



INTELLIGENT UPTIME TO GET MORE DONE.

The Volvo EC160C defines uptime in simple terms. Complete service access. Fast, easy routine maintenance. Long service intervals. Ground-level convenience. Add it all up and you've got the Volvo edge: a machine that works as hard as you – everyday. And because increased production results in increased profit, the Volvo EC160C is ready for you. It's got plenty of power and ideal capacity for a wide range of jobs. Get in and go to work. Grading, piping, excavation, trenching and more. It's time to grow your business. It's time to get more done.

Powerful V-ACT Volvo engine

For the strength behind all your jobs, the Volvo EC160C is equipped with a powerful new generation Tier 3 compliant V-ACT (Volvo Advanced Combustion Technology) engine. It delivers 117 hp (87 kW) of optimized output. And with high engine torque at low revs, Volvo achieves ultra-efficient fuel consumption.

Commanding hydraulic flow

The advanced hydraulic system is highly responsive, so it's easy to quickly get the job done. It's got the boom, arm and swing priority you need. And because of its precision, responsive control, you know exactly what to expect when you touch the joystick. In-cab operator-selectable hydraulic flow and pressure increases utility and ease of use with special attachments.

Quick fit versatility

Volvo hydraulic quick fit solutions make changing attachments quick and easy – all from the comfort and safety of the cab. Two S-type Volvo quick fit models are available to fit new and existing customer's buckets/attachments. Increased bucket speed, optional boom float position and a wide range of working modes gives you the perfect match for the application, attachment and terrain.

Service has been simplified

Maximum uptime is aided by easy service – that's why Volvo has simplified it. Ground level access makes inspection and service quick and easy. Change the oil, fuel and water separator filters, as well as drain the oil and access the hydraulic pump – all from the ground. Inside the cab, quickly check the engine oil level and perform self-diagnostics through the LCD monitor.

Daily maintenance with ease

The cab air filter is conveniently located outside the cab for easy replacement. Fuses are easy to check in a sealed, steel box behind the cab. The sloped track frame design allows for self-cleaning of mud and debris.

Intelligent hydraulic cooling system

Fan speed is hydraulically (not engine) driven, intuitively sensing hydraulic oil/engine temperature and automatically activating to keep the system regulated at an optimized temperature. O-ring faced sealing in all hydraulic connections add reliability. An anti-corrosive aluminium cooling module offers better heat dissipation and long life.

Common parts lower costs

Volvo designs all its machines with a common vision. The Volvo EC160C uses over 100 components and consumable parts common to other Volvo machines you may run. This results in higher availability of parts and lower operating costs.





• Simplified, ground level service access.

• Easy access to hydraulic pumps and filters.



• Safe, anti-slip steps and platforms.



• More care built in.

- Intelligent, advanced hydraulic system balances available engine power with hydraulic output for smooth, responsive control.
- Simplified, ground level service access, long service intervals and centralized lubrication points means more uptime.
- Quick and easy access to hydraulic pumps and filters.
- Anti-slip, punched steel platforms and walk areas offer superior grip and safety.
- More uptime from well-protected hydraulic lines and easy-access grease points.

DAY-IN, DAY-OUT ENDURANCE. EVERY YEAR.

There's enough on your mind. You don't want to have to wonder if your machine will start today or if your hydraulic pump can really handle the work during that upcoming big job. That's why the innovative Volvo EC160C is built with trusted Volvo quality through and through. While others may cut costs with cheap components, plastic parts or thin panels, Volvo puts reliability and enduring quality into all details. You can see and feel it. That means years from now you're not wondering about your Volvo – you're working and making money.

More quality built in

Walk around the EC160C. Climb in the cab. The quality isn't hard to find. There's rigid service doors, a sturdy engine hood and a protected electrical system. From the strengthened, high-tensile steel undercarriage frame and reinforced superstructure with double-welded corners to the heavy-duty booms and arms – it's built for reliability along with lower costs and high resale value.

Trust the strength of the track

The Volvo EC160C undercarriage and track are built for durability, reliability and stability. The lifetime greased sealed track link prevents grease leaks, reduces noise and guarantees longevity.

Intelligent, tough, high-tech

The Volvo EC160C blends intelligence and toughness in innovative new ways. And even though it's high-tech, it's easy to learn and operate. The machine's computer balances maximum available horsepower to hydraulic output, preventing engine overload – regardless of load on the pumps or engine speed. Volvo can do this because it's a Volvo engine, designed by Volvo engineers to specifically work with Volvo components.

Rely on your Volvo dealer for the support services you need:

CareTrack monitors it all

CareTrack is an optional GPS monitoring program that works with the machine's diagnostic system. Installation is simple. Track geographic machine location, usage, fuel consumption and more from your computer. Maximize uptime through important service reminders. CareTrack also offers theft protection by allowing you to limit geographic areas or hours of the day the machine can be operated.

MATRIS reports on your efficiency

MATRIS delivers detailed operating history analysis about the utilization and efficiency factors that influence your operating costs. MATRIS turns the data captured inside the machine's computer into easy-to-use graphs and reports. Maximize machine and operator performance, while reducing maintenance costs and increasing service life.

PROSIS makes parts ordering faster

PROSIS is a CD-ROM application that makes it quick and easy for your Volvo dealer to order all your Volvo CE product parts. Your dealer will help you find the right part, place your order and get you back up and running fast.



- Lifetime greased and sealed track link ensures long life.
- Rely on the quality for a wide variety of jobs.
- Optional protected arm with longer, reinforced strip and replaceable steel plates at both ends offers less wear and cheaper arm end maintenance.
- Reinforced, robotically-welded undercarriage frame distributes stress with rigid strength.
- Durable, standard undercover on the underside of the x-shaped frame provides extra protection.



• Your trust. Your satisfaction. Count on it.



• Lifetime greased and sealed track link.



• Underside bolt protection endures tough conditions.



• Volvo is the partner you can grow with.

YOUR OPTIONS ARE OPEN TO GREATER PROFITS.

Volvo is different from the rest. So are operators, applications and site conditions around the world. That's why Volvo helps keep everyone happy, comfortable and productive with optional equipment to suit individual needs. Extra protection, extra comfort or added strength can give you a big edge in performance and, most importantly, profits.

Hydraulic kits

A wide variety of hydraulic kits are available for various boom and arm combinations. Each kit maximizes performance according to the machine's boom and arm length/shape. Get the most out of rotating/tilting attachments, crushers and hammers. Choose between 1 or 2 pump flow for best performance.

Hydraulic quick fit

A Volvo hydraulic quick fit makes changing attachments quick and easy – all from the comfort and safety of the cab. Different quick fit types (universal and S-type) are available to fit new and existing customer's buckets/attachments.

Dozer blade

A front-end dozer blade increases machine versatility in job applications such as backfilling trenches and site clean up. It can also be used to level the excavator when working on slopes.

Wrist control joysticks - proportional control

Low-effort, wrist control joysticks provide smooth, precision control for increased comfort, efficiency and production. Wrist control joysticks with proportional control switches are also available.

Operator seats

Volvo offers a wide variety of ergonomic operator seats designed specifically for comfort and protection. All seats, from various adjustable models to the most advanced air-suspended models, provide excellent support and are individually adjustable to suit operator preferences.

Diesel-driven engine coolant heater

The diesel-driven engine coolant heater aids low temperature starting, while simultaneously warming the cab. Heating time duration can be adjusted, set and programmed in advance to engage at a specific date and time.

FOG and FOPS cab protection

For added safety and protection, FOG (Falling Object Guard) and FOPS (Falling Object Protective Structure) certified cabs provide peace-of-mind for tough conditions such as quarries and demolition. The front guard of the FOG unit is tiltable and supported by a gas strut for easy front window cleaning.

Straight travel pedal

A pedal located by the left foot rest operates both travel motors at the same time, providing convenience when traveling and efficient work control in applications such as pipe laying.

Rearview camera

Inside the cab, the wide screen color LCD of the IECU (Instrument Electronic Control Unit) provides a safe rear view when reverse travel is selected or of the right hand side of the superstructure when the swing function is activated. The protected rear and side view cameras can be switched manually using the selection switch on the keypad.

To customize your excavator with other optional equipment features to suit your application, contact your local Volvo dealer.



VOLVO OPTIONAL EQUIPMENT



Hydraulic kits
Hydraulic quick fit
Dozer blade

Wrist control joysticks
- proportional control
Operator seats
Diesel-driven engine
coolant heater

FOG and FOPS cab protection
Straight travel pedal
Rearview camera

NOTE: Some features listed as optional equipment are standard equipment in some markets. Some equipment features listed are not available in all markets. Not a complete list of available optional equipment features. See included specification sheet for a complete listing.

WALKAROUND. LOOK AROUND. EXPERIENCE IT.

MORE SAFETY

- **The new-design Volvo Care Cab**, with operator protective structure provides security.
- **Anti-slip steps and platforms** with punched steel plates for superior grip even when wet or icy.
- **Low engine emission levels and low noise.**
- **Reduced engine hood size/height** for better rear visibility.
- **Recessed bolts on superstructure** walk areas for less risk of trip hazard.
- **Lead-free exterior paint:** more harmony with the environment.

MORE PROFIT

- **New generation Volvo V-ACT engine:** powerful, innovative and efficient.
- Volvo continues to deliver **industry-leading fuel efficiency.**
- **Advanced hydraulic system** with priority functions and optional boom float position.
- **Optional universal quick fit** makes versatility easier.

MORE COMFORT

- **New larger, more comfortable cab** puts you in command with perfectly placed, ergonomic controls.
- **Roomy, adjustable seat** supports your whole body.



- **Top-mounted windshield wiper** cleans a wider area – including both upper corners.
- **Vibration dampening** protects against whole body fatigue for all-day production.
- **Electronic climate control system** delivers the highest capacity heating and cooling available.



MORE UPTIME

- **Simplified, ground level serviceability** means more uptime.
- **Easy access, centralized lubrication points.**
- **Easy-to-read LCD color monitor** for real-time information and trouble-shooting.
- **Easy to learn. Easy-to-operate. Easy to get more done.**

MORE QUALITY

- **Strengthened undercarriage frame** provides endurance against daily abuse.
- **Reinforced boom/arm and proven components** deliver every time.
- **Reinforced superstructure** with double welded corners.
- **Lifetime greased sealed track link** prevents leaks and guarantees long life.

SPECIFICATIONS

Engine

The next-generation Volvo diesel engine uses Volvo Advanced Combustion Technology (V-ACT) to deliver lower emissions and maintain superior performance and fuel efficiency. The EPA Tier 3 compliant engine uses precise, high-pressure fuel injectors, turbo charger and air-to-air intercooler and electronic engine controls to optimize machine performance.

Engine	Volvo D6E EBE3	
Max. power, at	30 r/s	1,800 r/min
Net (ISO 9249, SAE J1349)	87 kW	117 hp
Gross (SAE J1995)	98 kW	131 hp
Max. torque at 1,350 r/min	625 Nm	461 lb.ft
No. of cylinders	6	
Displacement	5.7 l	348 cu.in
Bore	98 mm	3.86"
Stroke	126 mm	4.96"

Electrical system

High-capacity electrical system that is well protected. Waterproof double-lock harness plugs are used to secure corrosion-free connections. The main relays and solenoid valves are shielded to prevent damage. The master switch is standard.

Voltage	24 V	
Batteries	2 x 12 V	
Battery capacity	140 Ah	
Alternator	28 V / 80 A	

Service refill capacities

Fuel tank	250 l	66 gal
Hydraulic system, total	265 l	70 gal
Hydraulic tank	123 l	32 gal
Engine oil	25 l	7 gal
Engine coolant	24 l	6 gal
Swing reduction unit	2.6 l	0.7 gal
Travel reduction unit	2 x 5.8 l	2 x 1.5 gal

Swing system

The swing system uses an axial piston motor, driving a planetary gearbox for maximum torque. An automatic holding brake and anti-rebound valve are standard.

Max. swing speed	11.9 r/min	
Max. swing torque	51.7 kNm	

Drive

Each track is powered by an automatic two-speed shift travel motor. Track brakes are multi-disc, spring-applied and hydraulically released. The travel motor, brake and planetary gears are well protected within the track frame.

Max. drawbar pull (tractive effort)	145 kN	32,520 lb
Max. travel speed	3.0/5.6 km/h	1.9/3.5 mph
Gradeability	35°	70%

Undercarriage

The undercarriage has a robust X-shaped frame. Greased and sealed track links are standard.

Track pads	2 x 44	
Link pitch	190 mm	7.5
Shoe width, triple grouser	500/600/700/800/900 mm 20"/24"/28"/32"/36"	
Bottom rollers	2 x 7	
Top rollers	2 x 2	

Hydraulic system

The hydraulic system, also known as the "Integrated work mode control" is designed for high-productivity, high-digging capacity, high-maneuvering precision and excellent fuel economy. The summation system, boom, arm and swing priority along with boom, arm and bucket regeneration provide optimum performance. The following important functions are included in the system:

Summation system: Combines the flow of both hydraulic pumps to ensure quick cycle times and high productivity.

Boom priority: Gives priority to the boom operation for faster raising when loading or performing deep excavations.

Arm priority: Gives priority to the arm operation for faster cycle times in leveling and for increased bucket filling when digging.

Swing priority: Gives priority to swing functions for faster simultaneous operations.

Regeneration system: Prevents cavitation and provides flow to other movements during simultaneous operations for maximum productivity.

Power boost: All digging and lifting forces are increased.

Holding valves: Boom and arm holding valves prevent the digging equipment from creeping.

Main pump:

Type: 2 x variable displacement axial piston pumps
Maximum flow: 2 x 145 l/min **2 x 38 gpm**

Pilot pump:

Type: Gear pump
Maximum flow: 18 l/min **4.8 gpm**

Hydraulic motors:

Travel: Variable displacement axial piston motor with mechanical brake
Swing: Fixed displacement axial piston motor with mechanical brake

Relief valve setting:

Implement	32.4/34.3 Mpa	4,690/4,980 psi
Travel circuit	34.3 Mpa	4,980 psi
Swing circuit	26.5 Mpa	3,840 psi
Pilot circuit	3.9 Mpa	570 psi

Hydraulic cylinders:

Boom	2	Bore x Stroke	ø115 x 1,165 mm ø4.5 x 45.9"
Arm	1	Bore x Stroke	ø120 x 1,345 mm ø4.7 x 53.0"
Bucket	1	Bore x Stroke	ø105 x 1,000 mm ø4.1 x 39.4"

Cab

The new-design Volvo Care Cab, with operator protective structure provides security, along with more interior space, leg room and foot space. Audio system with remote control. 3 cup holders, 3 high-capacity outlets. Independently adjustable joystick consoles.

Excellent all-around visibility provided through maximum cab glass, transparent roof hatch and 2-piece sliding door window. The lift-up front windshield can easily be secured at the ceiling and the removable lower front glass can be stored in the side door. Interior lighting consists of one reading light and one cab light with timer.

The pressurized and filtered cab air is supplied by a 14-vent climate-control system, providing fast defrosting and high cooling and heating performance. Viscous/spring-mounted suspension cushions operator from vibrations.

Deluxe seat with adjustable height, tilt, recline, forward-back settings, retractable seat belt and selectable horizontal suspension for reduced whole body vibration.

Adjustable easy-to-read 6.4" LCD color monitor provides real-time information of machine functions, important diagnostic information and a wide variety of work tool settings. LCD monitor is switchable to rearview camera monitor (option).

Sound Level:

Sound level in cab according to ISO 6396
..... LpA 70 dB(A)

External sound level according to ISO 6395 and EU Directive 2000/14/EC
..... LwA 101 dB(A)

Ground pressure

• EC160C L with 5.2 m, 17' 1" boom, 2.6 m, 8' 6" arm, 470 kg, 1,040 lb bucket, 3,200 kg, 7,060 lb counterweight

Description	Shoe width	Operating weight	Ground pressure	Overall width
Triple grouser	500 mm, 20"	17,200 kg, 37,830 lb	48.6 KPa, 7.0 psi	2,490 mm, 8' 2"
	600 mm, 24"	17,400 kg, 38,340 lb	41.0 KPa, 5.9 psi	2,590 mm, 8' 6"
	700 mm, 28"	17,600 kg, 38,860 lb	36.3 KPa, 5.3 psi	2,690 mm, 8' 10"
	800 mm, 31"	18,000 kg, 39,730 lb	32.4 KPa, 4.7 psi	2,790 mm, 9' 2"
	900 mm, 35"	18,300 kg, 40,320 lb	29.4 KPa, 4.3 psi	2,990 mm, 9' 10"

• EC160C L with dozer blade with 5.2 m, 17' 1" boom, 2.6 m, 8' 6" arm, 470 kg, 1,040 lb bucket, 3,200 kg, 7,060 lb counterweight

Description	Shoe width	Operating weight	Ground pressure	Overall width
Triple grouser	500 mm, 20"	18,300 kg, 40,280 lb	52.0 KPa, 7.5 psi	2,490 mm, 8' 2"
	600 mm, 24"	18,500 kg, 40,780 lb	44.1 KPa, 6.4 psi	2,590 mm, 8' 6"
	700 mm, 28"	18,700 kg, 41,300 lb	38.2 KPa, 5.5 psi	2,690 mm, 8' 10"
	800 mm, 31"	19,100 kg, 42,180 lb	34.3 KPa, 5.0 psi	2,790 mm, 9' 2"
	900 mm, 35"	19,400 kg, 42,760 lb	31.4 KPa, 4.6 psi	2,990 mm, 9' 10"

Max. permitted buckets

Note: 1. Bucket size based on ISO 7451, heaped material with a 1:1 angle of repose.

2. "Max. permitted sizes" are for reference only and are not necessarily available from the factory.

3. Bucket widths are less than bucket's tip radius.

• EC160C L with pin-on bucket, 3,200 kg, 7,060 lb counterweight

Description	Max. bucket volume / weight	5.2 m, 17' 1" boom		
		2.3 m, 7' 7" arm	2.6 m, 8' 6" arm	3.0 m, 9' 10" arm
GP bucket 1.5 t/m ³ , 2,530 lb/yd³	l/kg	1,125/950	1,025/850	850/700
	yd ³ /lb	1.47/2,090	1.34/1,870	1.11/1,540
GP bucket 1.8 t/m ³ , 3,030 lb/yd³	l/kg	1,000/850	900/750	750/600
	yd ³ /lb	1.31/1,870	1.18/1,650	0.98/1,320

• EC160C L with quick fit bucket, 3,200 kg, 7,060 lb counterweight

Description	Max. bucket volume / weight	5.2 m, 17' 1" boom		
		2.3 m, 7' 7" arm	2.6 m, 8' 6" arm	3.0 m, 9' 10" arm
GP bucket 1.5 t/m ³ , 2,530 lb/yd³	l/kg	1,050/900	975/800	775/650
	yd ³ /lb	1.37/1,980	1.28/1,760	1.01/1,430
GP bucket 1.8 t/m ³ , 3,030 lb/yd³	l/kg	925/800	850/700	700/550
	yd ³ /lb	1.21/1,760	1.11/1,540	0.92/1,210

Dimensions

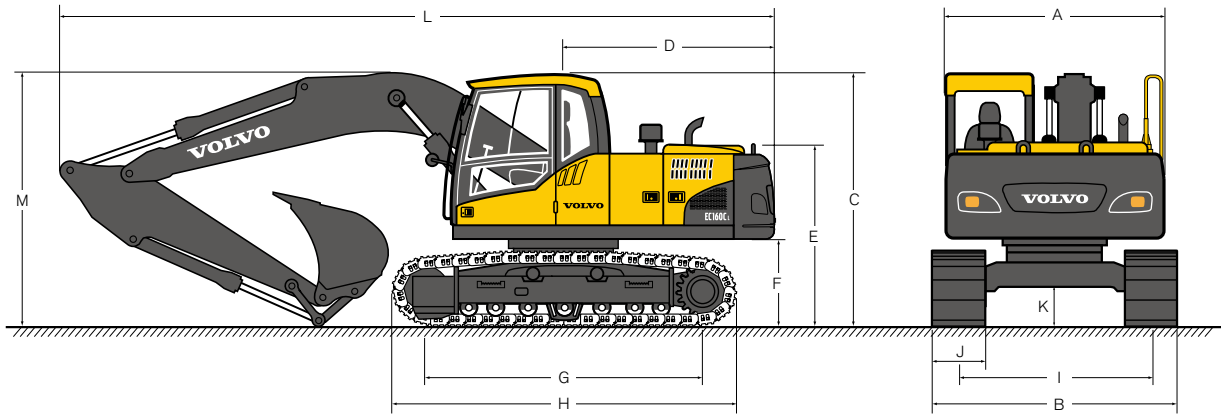

Description		5.2 m, 17' 1" boom		
		2.3 m, 7' 7" arm	2.6 m, 8' 6" arm	3.0 m, 9' 10" arm
A. Overall width of upper structure	mm, ft-in	2,490, 8' 2"	2,490, 8' 2"	2,490, 8' 2"
B. Overall width	mm, ft-in	2,590, 8' 6"	2,590, 8' 6"	2,590, 8' 6"
C. Overall height of cab	mm, ft-in	2,900, 9' 6"	2,900, 9' 6"	2,900, 9' 6"
D. Tail swing radius	mm, ft-in	2,450, 8' 0"	2,450, 8' 0"	2,450, 8' 0"
E. Overall height of engine hood	mm, ft-in	2,110, 6' 11"	2,110, 6' 11"	2,110, 6' 11"
F. Counterweight clearance *	mm, ft-in	1,010, 3' 4"	1,010, 3' 4"	1,010, 3' 4"
G. Tumbler length	mm, ft-in	3,180, 10' 5"	3,180, 10' 5"	3,180, 10' 5"
H. Track length	mm, ft-in	3,980, 13' 1"	3,980, 13' 1"	3,980, 13' 1"
I. Track gauge	mm, ft-in	1,990, 6' 6"	1,990, 6' 6"	1,990, 6' 6"
J. Shoe width	mm, in	600, 24"	600, 24"	600, 24"
K. Min. ground clearance *	mm, ft-in	460, 1' 6"	460, 1' 6"	460, 1' 6"
L. Overall length	mm, ft-in	8,780, 28' 10"	8,670, 28' 5"	8,710, 28' 7"
M. Overall height of boom	mm, ft-in	2,980, 9' 9"	2,900, 9' 6"	3,020, 9' 11"

* Without shoe grouser

• Boom

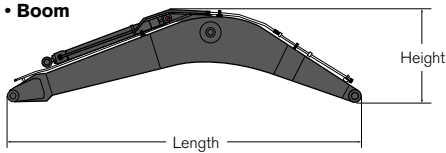

Description		5.2 m, 17' 1"
Length	mm, ft-in	5,400, 17' 9"
Height	mm, ft-in	1,640, 5' 5"
Width	mm, ft-in	565, 1' 10"
Weight	kg, lb	1,350, 2,980

* Includes arm cylinder, piping and pin

• Arm

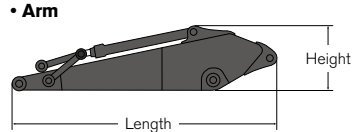

Description		2.3 m, 7' 7"	2.6 m, 8' 6"	3.0 m, 9' 10"
Length	mm, ft-in	3,240, 10' 8"	3,500, 11' 6"	3,900, 12' 10"
Height	mm, ft-in	855, 2' 10"	855, 2' 10"	845, 2' 9"
Width	mm, ft-in	395, 1' 4"	395, 1' 4"	395, 1' 4"
Weight	kg, lb	760, 1,680	775, 1,710	840, 1,850

* Includes bucket cylinder, linkage and pin

• Front dozer blade

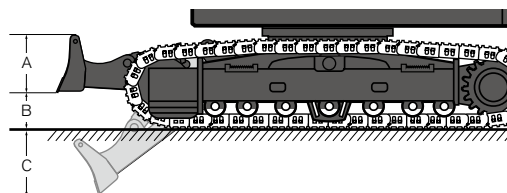

Description		Measurement
A. Height	mm, ft-in	503, 1' 8"
Width	mm, ft-in	2,800, 9' 2"
Weight	kg, lb	595, 1' 11"
B. Lift height	mm, ft-in	607, 2' 0"
C. Digging depth	mm, ft-in	710, 2' 4"

Working ranges & digging force

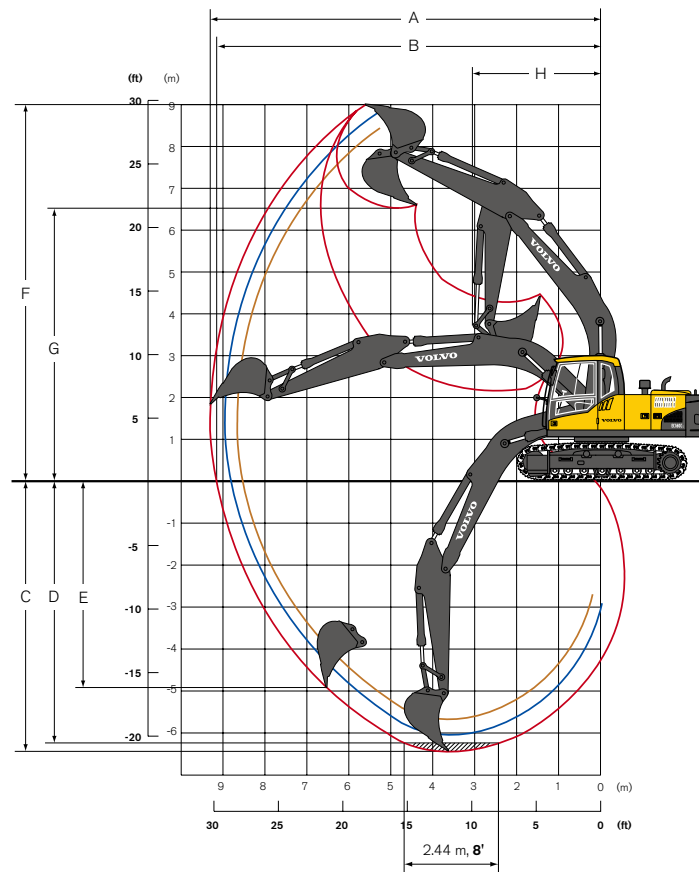

Machine with pin-on bucket		5.2 m, 17' 1" boom		
		2.3 m, 7' 7" arm	2.6 m, 8' 6" arm	3.0 m, 9' 10" arm
A. Max. digging reach	mm, ft-in	8,650, 28' 5"	8,970, 29' 5"	9,340, 30' 8"
B. Max. digging reach on ground	mm, ft-in	8,490, 27' 10"	8,810, 28' 11"	9,180, 30' 1"
C. Max. digging depth	mm, ft-in	5,740, 18' 10"	6,040, 19' 10"	6,440, 21' 2"
D. Max. digging depth (8' level)	mm, ft-in	5,430, 17' 10"	5,770, 18' 11"	6,200, 20' 4"
E. Max. vertical wall digging depth	mm, ft-in	4,070, 13' 4"	4,540, 14' 11"	4,960, 16' 3"
F. Max. cutting height	mm, ft-in	8,530, 28' 0"	8,790, 28' 10"	9,000, 29' 6"
G. Max. dumping height	mm, ft-in	6,110, 20' 1"	6,340, 20' 10"	6,540, 21' 5"
H. Min. front swing radius	mm, ft-in	3,070, 10' 1"	3,070, 10' 1"	3,070, 10' 1"









Digging forces with pin-on bucket		5.2 m, 17' 1" boom			
		2.3 m, 7' 7" arm	2.6 m, 8' 6" arm	3.0 m, 9' 10" arm	
Bucket radius	mm, in	1,315, 52"	1,315, 52"	1,315, 52"	
Breakout force - bucket (Normal/Power boost)	SAE J1179	kN, lb	99.2, 22,310/105.2, 23,660	99.2, 22,310/105.2, 23,660	99.2, 22,310/105.2, 23,660
	ISO 6015	kN, lb	111.3, 25,030/118.1, 26,550	111.3, 25,030/118.1, 26,550	111.3, 25,030/118.1, 26,550
Tearout force - arm (Normal/Power boost)	SAE J1179	kN, lb	84.9, 19,100/90.1, 20,260	75.5, 16,980/80.0, 17,990	68.4, 15,390/72.6, 16,320
	ISO 6015	kN, lb	87.3, 19,620/92.6, 20,820	77.4, 17,400/82.1, 18,460	69.9, 15,720/74.1, 16,670
Rotation angle, bucket	deg.	174	174	174	

Lifting capacity

At the arm end without bucket.

For lifting capacity including bucket, simply subtract actual weight of the direct fit bucket or the bucket with quick fit from the following values.

• EC160C L

 Across undercarriage  Along undercarriage	Lifting hook related to ground level	3.0 m, 10'		4.5 m, 15'		6.0 m, 20'		7.5 m, 25'		Max. reach								
																Max.		
		t	lb	t	lb	t	lb	t	lb	t	lb	t	lb	t	lb	m/ft		
Boom 5.2 m, 17' 1" + Arm 2.3 m, 7' 7" + Shoe 600 mm, 24" + Counterweight 3,200 kg, 7,060 lb	7.5 m 25'													4.1	*9,127	4.1	*9,127	4.4/14.44
	6.0 m 20'													4.2	*9,348	3.5	7,804	5.9/19.36
	4.5 m 15'					4.7	*10,295	4.7	*10,295	4.4	*9,656	3.4	7,562	4.3	*9,414	2.8	6,195	6.8/22.31
	3.0 m 10'					6.2	*13,669	5.0	11,023	5.0	*11,045	3.3	7,297	3.9	8,620	2.5	5,467	7.3/23.95
	1.5 m 5'					7.8	*17,130	4.7	10,362	5.1	11,199	3.2	6,989	3.8	8,267	2.4	5,203	7.4/24.28
	0 m 0'	4.4	*9,744	4.4	*9,744	7.7	16,909	4.5	9,987	5.0	10,957	3.1	6,768	3.9	8,488	2.4	5,313	7.2/23.62
	-1.5 m -5'	9.5	*20,833	8.3	*18,342	7.6	16,799	4.5	9,921	4.9	10,891	3.0	6,702	4.3	9,458	2.7	5,886	6.6/21.65
	-3.0 m -10'	12.3	*27,072	8.5	18,629	7.7	16,953	4.6	10,053					5.5	12,037	3.4	7,407	5.6/18.37
	-4.5 m -15'																	
Boom 5.2 m, 17' 1" + Arm 2.6 m, 8' 6" + Shoe 600 mm, 24" + Counterweight 3,200 kg, 7,060 lb	7.5 m 25'													3.9	*8,554	3.9	*8,554	4.8/15.75
	6.0 m 20'									3.9	*8,620	3.5	7,804	3.8	*8,444	3.3	7,253	6.3/20.67
	4.5 m 15'					4.3	*9,480	4.3	*9,480	4.1	*9,105	3.5	7,650	3.8	*8,289	2.7	5,864	7.1/23.29
	3.0 m 10'	9.2	*20,172	9.2	*20,172	5.8	*12,831	5.1	11,133	4.8	*10,560	3.3	7,341	3.7	8,179	2.4	5,203	7.5/24.60
	1.5 m 5'					7.5	*16,446	4.7	10,406	5.1	11,244	3.2	7,011	3.7	8,091	2.3	5,115	7.6/24.93
	0 m 0'	5.1	*11,243	5.1	*11,243	7.7	16,887	4.5	9,987	5.0	10,957	3.1	6,768	3.7	8,047	2.3	5,049	7.5/24.61
	-1.5 m -5'	9.0	*19,841	8.2	18,122	7.6	16,733	4.5	9,833	4.9	10,847	3.0	6,658	4.0	8,863	2.5	5,512	6.9/22.64
	-3.0 m -10'	12.7	*27,932	8.4	18,408	7.6	16,843	4.5	9,943					5.0	10,957	3.1	6,768	6.0/19.69
	-4.5 m -15'	10.2	*22,421	8.6	19,026									7.0	*15,454	4.9	10,869	4.4/14.44
Boom 5.2 m, 17' 1" + Arm 3.0 m, 9' 10" + Shoe 600 mm, 24" + Counterweight 3,200 kg, 7,060 lb	7.5 m 25'													3.6	*7,959	3.6	*7,959	5.4/17.72
	6.0 m 20'									3.5	*7,760	3.5	*7,760	3.3	*7,297	3.0	6,658	6.7/21.98
	4.5 m 15'									3.8	*8,422	3.6	7,826	3.3	*7,165	2.5	5,512	7.5/24.61
	3.0 m 10'	7.8	*17,174	7.8	*17,174	5.4	*11,795	5.2	11,398	4.5	*9,965	3.4	7,496	3.8	8,378	2.4	5,379	7.9/25.92
	1.5 m 5'	5.3	*11,596	5.3	*11,596	7.1	*15,564	4.8	10,582	5.2	11,354	3.2	7,121	3.7	8,201	2.4	5,203	8.0/26.25
	0 m 0'	5.7	*12,522	5.7	*12,522	7.8	17,130	4.6	10,053	5.0	11,023	3.1	6,834	3.7	8,047	2.3	5,049	7.8/25.59
	-1.5 m -5'	8.5	*18,827	8.2	17,968	7.6	16,733	4.5	9,833	4.9	10,869	3.0	6,680	3.7	8,223	2.3	5,159	7.3/23.95
	-3.0 m -10'	13.1	*28,924	8.3	18,188	7.6	16,777	4.5	9,877	5.0	10,913	3.1	6,724	4.5	9,855	2.8	6,128	6.5/21.33
	-4.5 m -15'	11.1	*24,559	8.5	18,739	7.5	*16,535	4.6	10,207					6.6	*14,594	4.1	8,929	5.0/16.40

- Notes:
1. Machine in "Fine Mode-F" (Power Boost) for lifting capacities.
 2. The above loads are in compliance with SAE J1097 and ISO 10567 Hydraulic Excavator Lifting Capacity Standards.
 3. Rated loads do not exceed 87% of hydraulic lifting capacity or 75% of tipping load.
 4. Rated loads marked with an asterisk (*) are limited by hydraulic capacity rather than tipping load.

STANDARD EQUIPMENT

Engine

Turbocharged, 4-stroke diesel engine with water cooling, direct injection and charged air cooler that meets EPA (Environmental Protection Agency) Tier 3 emission standards
3-stage air filter with indicator and precleaner
Intake air pre-heater
Electric engine shut-off
Fuel filter and water separator
Alternator, 80 A

Electric/Electronic control system

Contronics
– Advanced mode control system
– Self-diagnostic system
Machine status indication
Engine speed sensing power control
Automatic idling system
One-touch power boost
Safety stop/start function
Adjustable LCD color monitor
Master electrical disconnect switch
Engine restart prevention circuit
High-capacity halogen lights:
– Frame mounted 2
– Boom mounted 2
Travel alarm
Batteries, 2 x 12 V / 140 Ah
Start motor, 24 V / 4.8 kW

Hydraulic system

Automatic sensing hydraulic system
– Summation system
– Boom priority
– Arm priority
– Swing priority
Cab adjustment of auxiliary hydraulic

pressure and flow
Hydraulic piping:
– Hammer & shear: 1 pump flow
– Quick fit piping
Boom, arm and bucket regeneration valves
Swing anti-rebound valves
Boom and arm holding valves
Multi-stage filtering system
Boom cylinders (x2)
Cylinder cushioning
Cylinder contamination seals
Auxiliary hydraulic valve
Automatic two-speed travel motors
Hydraulic oil, ISO VG 46

Superstructure

Access way with handrail
Full height counterweight:
3,200 kg, **7,060 lb**
Tool storage area
Service walkway with anti-slip grating
Undercover (heavy-duty 4.5 mm, **0.18"**)

Cab and interior

Fabric seat with heater and air suspension
2-button control for hammer/shear auxiliary hydraulics
Control joysticks with 4 switches each
Travel pedals with hand levers
Pilot control pattern change
Heater & air-conditioner, automatic
Hydraulic dampening cab mounts
Adjustable operator seat and joystick control console
Hydraulic safety lock lever
Cab, all-weather sound suppressed, includes:
– Ashtray
– Cup holder (x3)
– Lighter

– Door locks
– Tinted glass
– Floor mat
– Horn
– Large storage area
– Pull-up type front window
– Removable lower windshield
– Seat belt
– Safety glass, light tinted
– Sun shields, front, roof, rear
– Windshield wiper with washer and intermittent feature
– AM/FM stereo with cassette includes flexible antenna
Anti-vandalism kit assembly preparation
Opening top hatch
Master key
Straight travel pedal

Undercarriage

Hydraulic track adjusters
Greased and sealed track link
Track guard
Undercover (4.5 mm, **0.18"**)
Standard roller guard

Track equipment

Track pads 600 mm, **24"** with triple grousers

Digging equipment

Boom: 5.2 m, **17' 1"** general purpose
Arm: 2.6 m, **8' 6"** general purpose without wear strips
Centralized lubrication

Service

Tool kit, daily maintenance

OPTIONAL EQUIPMENT

Engine

Block heater: 120 V
Oil-bath pre-cleaner
Diesel coolant heater, programmable
Water separator with heater
Fuel filler pump: 50 l/min, **13.2 gpm** with automatic shut-off

Electric

Extra lamps:
– Cab-mounted 1
– Counterweight-mounted 1
Anti-theft system
Rotating warning beacon

Hydraulic system

Hose rupture valve: boom, arm
Overload warning device

Hydraulic piping:
– Hammer & shear, 2-pump flow
– Slope & rotator
– Grapple
– Oil leak (drain) line
Volvo hydraulic quick fit, S1, S6 size
Hydraulic oil, ISO VG 32
Hydraulic oil, ISO VG 68
Hydraulic oil, biodegradable 32
Hydraulic oil, biodegradable 46
Boom float function

Cab and interior

Fabric seat
Fabric seat with heater
Control joystick with semi-long levers
Control joystick with proportional control
Falling object guard (FOG)
– Cab-mounted

Cab-mounted falling object protective structure (FOPS)
Protective screen for front window
Rain shield
Lower wiper with intermittent control
Anti-vandalism kit
Rearview camera

Undercarriage

Full track guard

Digging equipment

Arm: 2.3 m, **7' 7"**
2.6 m, **8' 6"** general purpose without wear strips
3.0 m, **9' 10"**

Service

Tool kit



Volvo Construction Equipment is different. It's designed, built and supported in a different way. That difference comes from an engineering heritage of over 170 years. A heritage of thinking first about the people who actually use the machines. About how to help them be safer, more comfortable, more productive. About the environment we all share. The result of that thinking is a growing range of machines and a global support network dedicated to helping you do more. People around the world are proud to use Volvo. And we're proud of what makes Volvo different – **More care. Built in.**



Not all products are available in all markets. Under our policy of continuous improvement, we reserve the right to change specifications and design without prior notice. The illustrations do not necessarily show the standard version of the machine.

VOLVO

Construction Equipment

Volvo Construction Equipment North America, Inc.

One Volvo Drive, Asheville, NC 28803-3447
www.volvoce.com

Ref. No. 22 C 100 2693
Printed in USA 10/07 – 5,0
Volvo, Asheville

English
USA